



Nuovo 324 Giravite TOP



SUPER OFFERTA

EDIZIONE 2 - 2019

€ Senza IVA - 60/2019

VALIDA FINO AL 31/01/2020



COSA SONO GLI ICONIC PRODUCT?

Gli **Iconic Product** sono prodotti **unici** sul Mercato che si distinguono per **design**, **funzionalità** e **prestazioni**. Sono i prodotti **TOP di gamma** e **più performanti** che puoi trovare solo all'interno dell'offerta USAG e che, più di altri, rappresentano il nostro prestigioso marchio.

Scegliere un **Iconic Product** significa prediligere **qualità ed eccellenza**.
Tu, che sei un professionista, ti meriti i migliori utensili in commercio!

PRODOTTI UNICI SUL MERCATO PER:

✓ DESIGN

✓ FUNZIONALITÀ

✓ PRESTAZIONI



PAGINA

4

324

PAGINA

8

150 AX

PAGINA

14

280 T

PAGINA

20

285

PAGINA

22

285 KA

PAGINA

30

237 A

PAGINA

66

207 E

PAGINA

74

443 N

SOLO USAG TE LI PUÒ OFFRIRE!

Indice per articolo a pagina 83

Giraviti

NEW



PAGINA
4

Pinze

NEW



PAGINA
7

Chiavi maschio ed inserti



PAGINA
14

Chiavi di manovra



NEW

PAGINA
20

Cricchetti e bussole



NEW

PAGINA
28

Serraggio controllato



PAGINA
33

Moduli ed assortimenti

NEW



PAGINA
34

Contenitori portautensili



NEW

PAGINA
42

Carrelli ed armadi

NEW



PAGINA
46

Banchi da lavoro



PAGINA
56

Prolunghe a catena



NEW

PAGINA
58

Pneumatica

NEW



PAGINA
60

Illuminazione

NEW



PAGINA
63

Manutenzione e mestieri

NEW



PAGINA
66

Scarpe da lavoro



PAGINA
73

Autoriparazione

NEW



PAGINA
74



NUOVI GIRAVITI 324

Il giravite 324 si rinnova. Restano uguali le caratteristiche di progetto, migliorano materiali e finiture per renderlo il top della scelta sul mercato.



IMPUGNATURA TRIMATERIALE

1. Esterno in poliuretano resistente ad olii ed agenti chimici.
2. Corpo in poliammide resistente agli sforzi.
3. Interno in poliammide ad alta densità per un perfetto accoppiamento alla lama.

RIVESTIMENTO SOFT GRIP

Miglior comfort durante l'uso.
Maggior trasmissione della coppia.

LAMA RINFORZATA

Acciaio al cromo silicio vanadio per la massima resistenza meccanica.

PUNTA AL TOP

Finitura zincata. Geometria perfetta. Trattamento anti corrosione.

NEW

STOP

GEOMETRIA
ANTI-ROTOLOMENTO

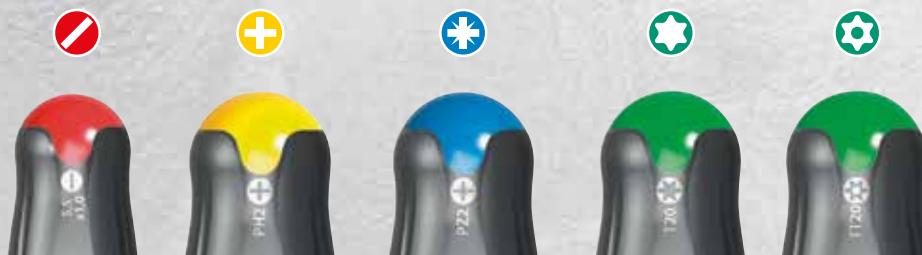

NEW

324 SH8

Cod. U03240650



8
PEZZI

Serie di 8 giraviti per viti con intaglio e impronta a croce PHILLIPS®

- 324 D/0,4x2,5x50
- 324/0,5x3x75-0,8x4x100-1x5,5x125-1,2x6,5x150
- 324 PH/0x75-1x75-2x100

~~€ 42,84~~

€ 27,50

NEW

324 SH12

Cod. U03240651



12
PEZZI

Serie di 12 giraviti per viti con intaglio, impronta a croce PHILLIPS® e impronta a croce POZIDRIV® - SUPADRIV®

- 324 D/0,4x2,5x50
- 324/0,5x3x75-0,8x4x100-1x5,5x125-1,2x6,5x150
- 324 N/1x5,5x35
- 324 PH/0x75-1x75-2x100
- 324 NPH/2x35
- 324 PZ/1x75-2x100

~~€ 72,49~~

€ 49,00

NEW

324 STX/S7

Cod. U03240662



7
PEZZI

Serie di 7 giraviti con impronta TORX® Tamper Resistant

- 324 STX T10x75-T15x75-T20x100-T25x100-T27x100-T30x125-T40x150

~~€ 82,00~~

€ 57,00

NUOVI GIRAVITI ISOLATI 1000 V



091 D/SH5

Cod. U00910119



5
PEZZI

Serie di 5 giraviti SLIM per viti con intaglio
e per viti con impronta a croce PHILLIPS®

- 092 D/0,6x3,5x100-0,6x4x100-1x5,5x125
- 092 DPH/1x100-2x125

~~€ 48,47~~

€ 34,00

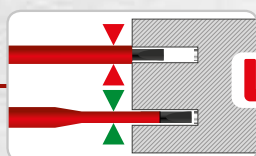

USAG SLIM



1000 V



  1000 V

091 SH5

Cod. U00910100



5
PEZZI

Serie di 5 giraviti per viti con intaglio
e per viti con impronta a croce PHILLIPS®

- 092/0,5x3x75-0,8x4x100-1x5,5x125
- 092 PH/1x100-2x125

~~€ 39,89~~

€ 29,50

NEW



  1000 V

091 SH8

Cod. U00910106



8
PEZZI

Serie di 8 giraviti per viti con intaglio,
per viti con impronta a croce PHILLIPS® e
impronta a croce POZIDRIV® - SUPADRIV®

- 091/0,5x3x75-0,8x4x100-1x5,5x125-1,2x6,5x150
- 091 PH/1x100-2x125
- 091 PZ/1x100-2x125

~~€ 68,60~~

€ 48,00

NUOVE PINZE ISOLATE 1000 V

NEW

**CERNIERA APERTA CON
ARTICOLAZIONE FORGIATA**

EN 60900



**TAGLIENTI TEMPRATI
AD INDUZIONE**

per la massima efficacia
nel taglio del filo dolce, di
media durezza e duro

**IMPUGNATURE ERGONOMICHE
ISOLATE BIMATERIALE**



1000 V

085 EX/SE2

Cod. U00850120

2
PEZZI

**Assortimento con pinza universale e
tronchese a tagliente diagonale isolati 1000 V**

- 085 EX 180
- 087 EX 160

~~€ 71,20~~

€ 49,80

NEW



NEW



1000 V

085 EX/SE3

Cod. U00850121

2
PEZZI

**Assortimento con pinza universale, pinza
a becchi mezzotondi diritti e tronchese a
tagliente diagonale isolati 1000 V**

- 081 EX 160
- 085 EX 180
- 087 EX 160

~~€ 109,10~~

€ 76,00

GAMMA PINZE "AX": IL TOP DELLE PERFORMANCE

FINITURA CROMATA. IMPUGNATURE BIMATERIALE.

150 AX

TAGLIENTI TEMPRATI AD INDUZIONE
per la massima efficacia nel taglio del filo armonico



YouTube

FULCRO PIÙ VICINO AI TAGLIENTI
per il minimo sforzo durante il taglio



**Taglia fino a Ø 2 mm di filo armonico
con il 30% in meno di forza**
rispetto al valore massimo
indicato dalle normative europee
ISO5749 (tronchesi) - ISO5746 (pinze)



**NUOVA
IMPUGNATURA USAG**

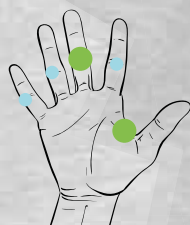

**PRODOTTI
SUL MERCATO**

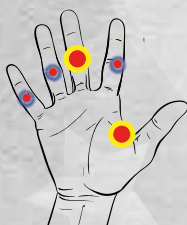

- SFORZO

+ SFORZO

Minimo sforzo risultante dagli studi
sugli sforzi muscolari effettuati
dal prestigioso istituto americano US Ergonomics

**ASOLA
DI AGGANCIO**

**IMPUGNATURE ERGONOMICHE
BIMATERIALE**





150 AX/SE3

Cod. U01500201

3
PEZZI

Assortimento con pinza universale, pinza a becchi mezzotondi diritti e tronchese a tagliente diagonale

- Pinza universale 150 AX 180
- Pinza a becchi mezzotondi lunghissimi diritti 133 AX 160
- Tronchese a grande effetto a tagliente diagonale 188 AX 160

~~€ 81,00~~

€ 56,00



150 AX/SE2

Cod. U01500200

2
PEZZI

Assortimento con pinza universale e tronchese a tagliente diagonale

- Pinza universale 150 AX 180
- Tronchese a grande effetto a tagliente diagonale 188 AX 160

~~€ 53,00~~

€ 38,00



150 AX/SP2

Cod. U01500202

2
PEZZI

Assortimento con pinza universale e pinza regolabile

- Pinza universale 150 AX 180
- Pinza regolabile a cerniera chiusa 180 C 250

~~€ 55,80~~

€ 38,00



**SISTEMA DI APERTURA
INNOVATIVO BREVETTATO**



134 A

Cod. U01340100

MAX Ø
60
mm

Pinza regolabile autobloccante con ganasce concave

- Ganasce forgiate
- Dentatura studiata per una presa perfetta anche su tondo
- Sistema di apertura brevettato ed integrato nei manici
- Rullino di regolazione della presa integrato sul manico superiore

~~€ 50,50~~

€ 35,50



135 A

Cod. U01350505

MAX Ø
80
mm

**Pinza regolabile autobloccante a cremagliera
con ganasce corte**

- Ganasce forgiate
- Dentatura studiata per una presa perfetta anche su tondo
- Sistema di apertura brevettato ed integrato nei manici
- Rullino di regolazione della presa integrato sul manico superiore
- Cremagliera a 5 posizioni

~~€ 59,50~~

€ 41,50



135 B

Cod. U01350510

MAX Ø
110
mm

**Pinza regolabile autobloccante a cremagliera
con ganasce lunghe**

~~€ 64,50~~

€ 45,00



135 C

Cod. U01350530

MAX Ø
135
mm

**Pinza regolabile autobloccante a cremagliera a
grande capacità**

~~€ 78,50~~

€ 55,00

NUOVA PINZA UNIVERSALE MULTIFUNZIONE

TAGLIENTI TEMPRATI AD INDUZIONE
per la massima efficacia nel taglio del filo armonico

FULCRO PIÙ VICINO AI TAGLIENTI
per il minimo sforzo durante il taglio

**IMPUGNATURE ERGONOMICHE
BIMATERIALE**



YouTube

200 mm

NEW

155 AX

Cod. U01550001

€ 50,00

€ 29,00

PROFILI ESAGONALI

**GEOMETRIA DELLE
GANASCE STUDIATA PER
LA PRESA DI UN ESAGONO**



PROFILI TONDI

**INTAGLIO RICAVATO NELLA
DENTATURA PER UNA PRESA
SICURA DI BARRE TONDE,
ANCHE FILETTATE**

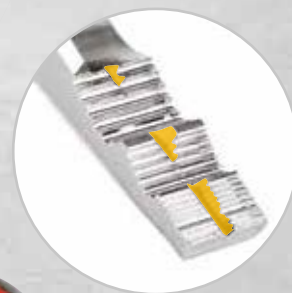

MASSIMA RESISTENZA



Misure piccole

NEW



127 N/SE4S

Cod. U01270046

4
PEZZI

Serie 4 pinze per anelli elastici

- Pinze per anelli elastici interni **127 N 12÷25-127 PN 12÷25**
- Pinze per anelli elastici esterni **128 N 10÷25-128 PN 10÷25**

~~€ 81,60~~

€ 57,00

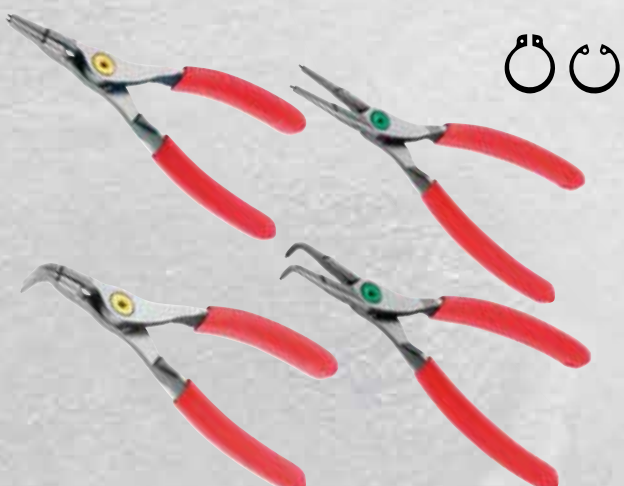

Misure grandi

127 N/SE4

Cod. U01279000P

4
PEZZI

Serie 4 pinze per anelli elastici

- Pinze per anelli elastici interni **127 N 19÷60-127 PN 19÷60**
- Pinze per anelli elastici esterni **128 N 19÷60-128 PN 19÷60**

~~€ 88,60~~

€ 62,00

MASSIMA ACCESSIBILITÀ



PUNTE E BECCHI
IN CORPO UNICO

PVC

NEW

Misure piccole

127 C/SE4S

Cod. U01270045

4
PEZZI

Serie 4 pinze per anelli elastici

- Pinze per anelli elastici interni 127 C 12÷25-127 CP 12÷25
- Pinze per anelli elastici esterni 128 C 10÷25-128 CP 10÷25

~~€ 68,00~~

€ 47,00

NEW

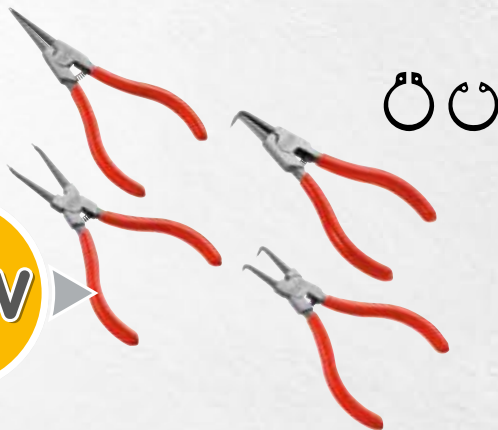

Misure grandi

127 C/SE4

Cod. U01270040

4
PEZZI

Serie 4 pinze per anelli elastici

- Pinze per anelli elastici interni 127 C 19÷60-127 CP 19÷60
- Pinze per anelli elastici esterni 128 C 19÷60-128 CP 19÷60

~~€ 74,00~~

€ 52,00

NEW

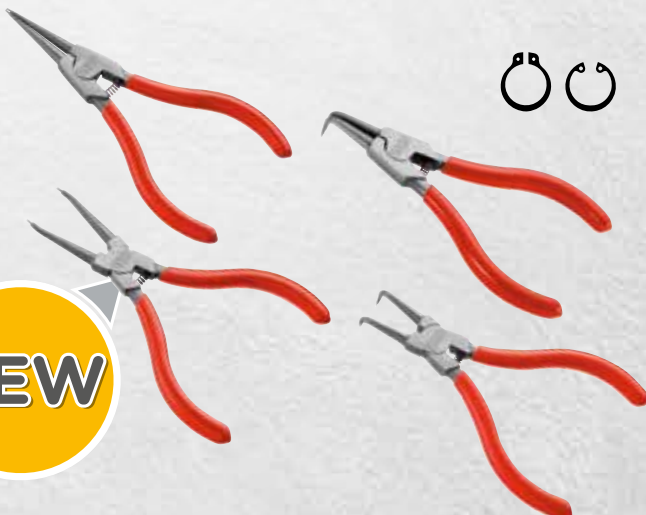

280 T

CHIAVE A T CON MASCHIO ESAGONALE



 YouTube



TRAVERSINO FISSO
Massima resistenza.



ACCIAIO SPECIALE
al cromo vanadio.



CHIAVI USAG



ALTRE CHIAVI

SICUREZZA GARANTITA

- +30% resistenza alla torsione rispetto alla norma ISO 2936.
- Raggiunta la coppia di rottura, la chiave si deforma senza spezzarsi.





280 T/SE7

Cod. U02800903



7
PEZZI

Serie di 7 chiavi a T con maschio esagonale

- 280 T/2-2,5-3-4-5-6-8 mm
- Per viti con esagono incassato
- Acciaio speciale altamente legato al cromo vanadio
- Esecuzione cromata con estremità brunate per garantire la precisione dimensionale ed il perfetto accompagnamento della vite

~~€ 102,20~~

€ 71,50



280 TTS/SE6

Cod. U02800760



6
PEZZI

Serie di 6 chiavi a T maschio esagonali con testa sferica

- 280 TTS/2,5-3-4-5-6-8 mm
- Per viti con esagono incassato
- Acciaio speciale altamente legato al cromo vanadio
- Esecuzione cromata con estremità brunate
- Modello che permette di operare con inclinazioni fino a 30° rispetto all'asse della vite
- Massima accessibilità con la testa sferica

~~€ 89,70~~

€ 62,80



280 TSTX/SE4

Cod. U02800790



4
PEZZI

Serie di 4 chiavi a T con impronta TORX® a testa sferica

- 280 TSTX/T15-T20-T25-T30
- Acciaio speciale altamente legato al cromo vanadio
- Esecuzione cromata con estremità brunate
- Modello che permette di operare con inclinazioni fino a 30° rispetto all'asse della vite
- Massima accessibilità con la testa sferica

~~€ 74,80~~

€ 52,50



280 TK/SE6

Cod. U02800020



6
PEZZI

Serie di 6 chiavi a T maschio esagonale con traversino scorrevole

- 280 TK/2,5-3-4-5-6-8 mm
- Per viti con esagono incassato
- Traversino scorrevole che permette di avere maggiore accessibilità rispetto alla chiave standard
- Fermo di sicurezza che impedisce l'estrazione del traversino
- Acciaio speciale altamente legato al cromo vanadio
- Esecuzione cromata con estremità brunate per il gambo
- Esecuzione interamente brunita per il traversino
- Estremità dimensionate per il perfetto accoppiamento con la vite

~~€ 90,60~~

€ 60,00



333 K/B10

Cod. U03330043



10
PEZZI

Assortimento COMBIDRIVE in astuccio di nylon

- Fornito con una selezione di lame
- Include un astuccio da cintura in nylon

DESCRIZIONE	ARTICOLO/MISURA	PZ
Impugnatura Combidrive	333 K	1
Lame reversibili ad intaglio	333 I 0,6x3,5/0,8x4 1x5,5/1,2x6,5	2
Lame reversibili a croce PH	333 PH 0-1/2-3	2
Lame reversibili TORX®	333 STX/ T7-T8/T9-T10/T15-T20/	5
Tamper Resistant	T25-T27/T30-T40	

~~€ 120,99~~

€ 77,00

3 IN 1 COMBIDRIVE



YouTube

1

GIRAVITE CON CRICCHETTO REVERSIBILE



2

GIRAVITE CON IMPUGNATURA A T



3

GIRAVITE CORTO PORTA INSERTI

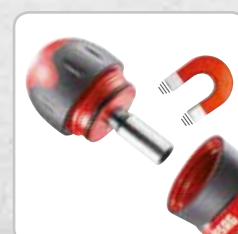



280 LTS/S9

Cod. U02800084



9
PEZZI

**Serie di 9 chiavi maschio esagonale
lunghe testa sferica**

• 280 LTS/1,5-2-2,5-3-4-5-6-8-10 mm

~~€ 29,00~~

€ 18,20



280 LTSTX/S8

Cod. U02800078



8
PEZZI

**Serie di 8 chiavi maschio lunghe testa
sferica TORX®**

• 280 LTSTX/T10-T15-T20-T25-T27-T30-T40-T45

~~€ 52,50~~

€ 36,80



280 XLTS/S9

Cod. U02800184



9
PEZZI

**Serie di 9 chiavi maschio esagonale
extra-lunghe a testa sferica**

• 280 XLTS/1,5-2-2,5-3-4-5-6-8-10 mm

~~€ 32,04~~

€ 23,00

**Supporti
compatti
con sistema
di estrazione
rapida**



Estrazione della singola chiave
senza muovere le altre.



I denti d'aggancio garantiscono
la tenuta delle chiavi nel supporto



Il foro permette di appendere
il supporto

**MODELLO
EXTRA LUNGO
+30% RISPETTO
ALLE 280 LTS**

Just USAG



YouTube



1/4
280 g
mm
↔ 138
↑ 30
↙ 98

692 J32

Cod. U06920042

32
PEZZI

Assortimento di inserti con cricchetto

DESCRIZIONE	MISURA		PZ.
Inserti ad intaglio	4-5,5-6,5-8	⊖	4
Inserti a croce PHILLIPS®	PH 1-2-3	⊕	3
Inserti a croce POZIDRIV®	PZ 1-2-3	⊕	3
Inserti esagono maschio	3-4-5-6	⊙	4
Inserti TORX®	T8-10-15-20-20-25-25-30-40	⊗	9
Inserti TORX® Tamper Resistant	STX 10-15-20-25-27-30-40	⊗	7
Portainseri magnetico			1
Cricchetto			1

~~€ 46,60~~

€ 32,00



1/4
280 g
mm
↔ 138
↑ 30
↙ 98

692 J49

Cod. U06920041

49
PEZZI

Assortimento di inserti

DESCRIZIONE	MISURA		PZ.
Inserti ad intaglio	4-4,5-5,5-6,5-6,5-8	⊖	6
Inserti a croce PHILLIPS®	PH 1-1-2-2-2-3	⊕	6
Inserti a croce POZIDRIV®	PZ 1-1-2-2-2-3-3	⊕	7
Inserti esagono maschio	2-3-3-4-4-5-5-6-6	⊙	9
Inserti TORX®	TX 10-10-15-15-20-20-25-25-30-30	⊗	10
Inserti TORX® Tamper Resistant	STX 10-15-15-20-20-25-25-30-30-40	⊗	10
Portainseri magnetico			1

~~€ 36,00~~

€ 26,50



1/4
900 g
mm
↔ 215
↑ 45
↙ 150

692 J100

Cod. U06920043

100
PEZZI

Assortimento di inserti con impronte speciali

DESCRIZIONE	MISURA		PZ.
Inserti a intaglio	3-4-4,5-5-5,5-6-6,5-7-8	⊖	9
Inserti a croce	PH 00-0-1-1-2-2-3-4 - PZ 1-2-2-3-4	⊕ ⊕	13
Inserti esagono maschio	1,5-2-2,5-3-4-5-5,5-6-7-8 mm 1/16-5/64-3/32-7/64-1/8-9/64-5/32-3/16-7/32-1/4"	⊙	20
Inserti TORX®	T 8-9-10-15-20-25-27-30-40-45	⊗	10
Inserti TORX® Tamper Resistant	STX 8-10-15-20-25-27-30-35-40	⊗	9
Inserti Tri-Wing	1-2-3-4	⊕	4
Inserti Spanner	4-6-8-10-12	⊕	5
Inserti Torq-set	6-8-10	⊕	3
Inserti quadrati	0-1-2-2-3	⊖	5
Inserti Clutch	1/8-5/32-3/16-1/4-5/16	⊖	5
Inserti XZN	M5-M6-M8	⊖	3
Inserti esagono maschio con foro	2-2,5-3-4-5-6 mm - 5/64-3/32-7/64-1/8-9/64-5/32"	⊖	12
Portainseri magnetici	1/4x60mm		2

~~€ 55,50~~

€ 41,00





YouTube



Inserto portabussole



350 g | 125 mm | 35 mm | 65

1/4"



606 1/4" SK

Cod. U06060012

31 PEZZI

Assortimento inserti con cricchetto reversibile

DESCRIZIONE	PZ.	ART./MISURA
Cricchetto reversibile	1	237 1/4" SFK
Inserti ad intaglio	2	660 0,5x4-1x5,5
Inserti esagonali	9	660 E 1,5-2-2,5-3-4-5-6-7-8
Inserti a croce PHILLIPS®	3	660 PH 1-2-3
Inserti a croce POZIDRIV®- SUPADRIV®	3	660 PZ 1-2-3
Raccordo portainseri	1	660 Q 1/4"
Inserti TORX® Tamper Resistant	7	660 STX T10-T15-T20-T25-T27-T30-T40
Inserti TORX®	4	660 TX T6-T7-T8-T9
Prolunga magnetica	1	672 1/4" MG 100

~~€ 62,00~~

€ 44,00



265 g | 125 mm | 35 mm | 65

1/4"

5,5-6-7-8-9-10-11-12-13-14 mm

610 1/4" EFK

Cod. U06100001

11 PEZZI

Assortimento bussole ribassate con cricchetto reversibile

~~€ 81,50~~

€ 54,00

BUSSOLE ESAGONALI RIBASSATE

Garantiscono il doppio dell'accessibilità rispetto all'utilizzo di un cricchetto standard.



-50%



YouTube

285

CHIAVE COMBINATA



TESTA RIBASSATA
Massima accessibilità.

FORCHETTA INCLINATA
Angolo di 15° rispetto
all'asse della chiave.

SEZIONE A DOPPIA T
Massima resistenza alla flessione.

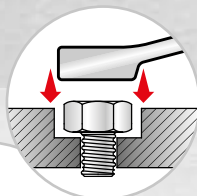

OCCHIO DISASSATO
Per dadi e bulloni incassati
in posizioni di difficile accesso.

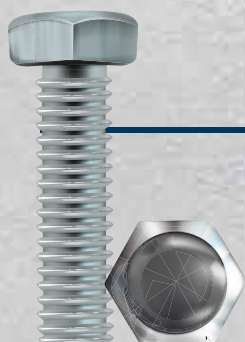

TOP PERFORMANCE

Resistenza alla torsione statica di anello e forchetta:
+50% rispetto alla norma ISO 1711-1

ISO 1711-1
SAE AS 954E

8÷19 mm



285 DS8

Cod. U02850863

Serie di 8 chiavi combinate

- 285/8-10-11-12-13-14-17-19 mm
- Fornita con supporto in plastica

8
PEZZI

~~€ 69,50~~

€ 45,00

7÷19 mm



285 DS12

Cod. U02850864

Serie di 12 chiavi combinate

- 285/7-8-10-11-12-13-14-15-16-17-18-19 mm
- Fornita con supporto in plastica

12
PEZZI

~~€ 103,00~~

€ 72,50

6÷32 mm



285 SE26

Cod. U02850861

Serie di 26 chiavi combinate

- 285/6-7-8-9-10-11-12-13-14-15-16-17-18-19-20-21-22-23-24-25-26-27-28-29-30-32 mm

26
PEZZI

~~€ 302,00~~

€ 211,00

285 KA

CHIAVE COMBINATA A CRICCHETTO CON ANELLO DI TENUTA



FORCHETTA CON SISTEMA ANTISLITTAMENTO DEL DADO

Maggiore tenuta durante la manovra.



YouTube

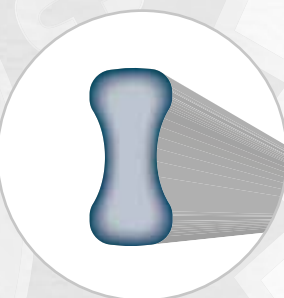

SEZIONE A DOPPIA T

Massima resistenza alla flessione.

POSIZIONE OTTIMALE



ANELLO IN ACCIAIO ARMONICO INTEGRATO NELL'OCCHIO POLIGONALE

Mantiene la posizione sul dado durante la manovra.



CRICCHETTO RESISTENTE

Resistenza alla torsione statica del cricchetto:
+50% rispetto alla norma ISO 1711-1

8÷19 mm



285 KA/SE5

Cod. U02856074

Serie di 5 chiavi combinate a cricchetto con anello di tenuta

• 285 KA/8-10-13-17-19 mm

5
PEZZI

~~€ 84,50~~

€ 59,00

8÷19 mm



285 KA/DS8

Cod. U02856058

Serie di 8 chiavi combinate a cricchetto con anello di tenuta

• 285 KA/8-10-11-12-13-14-17-19 mm

8
PEZZI

~~€ 140,00~~

€ 93,00



7÷19 mm

285 KA/DS12

Cod. U02856062

Serie di 12 chiavi combinate a cricchetto con anello di tenuta

• 285 KA/7-8-10-11-12-13-14-15-16-17-18-19 mm

12
PEZZI

~~€ 212,00~~

€ 149,00

Chiavi di manovra

8÷19 mm



TESTA SNODATA



285 KF/DS8

Cod. U02856158

8
PEZZI

Serie di 8 chiavi combinate a cricchetto snodate

• 285 KF/8-10-11-12-13-14-17-19 mm

~~€ 166,70~~

€ 115,00

8÷19 mm



CAMBIO DEL SENSO DI ROTAZIONE



285 KB/SR8

Cod. U02856339

8
PEZZI

Serie di 8 chiavi combinate a cricchetto piatte

• 285 KB/8-10-12-13-14-15-17-19 mm

~~€ 107,94~~

€ 76,00

NEW



6÷23 mm



283 SE9

Cod. U02831405

9
PEZZI

Serie di 9 chiavi poligonali doppie piegate

• 283 /6x7-8x9-10x11-12x13-14x15-16x17-18x19-20x22-21x23 mm

~~€ 99,49~~

€ 69,00

1 1/2"

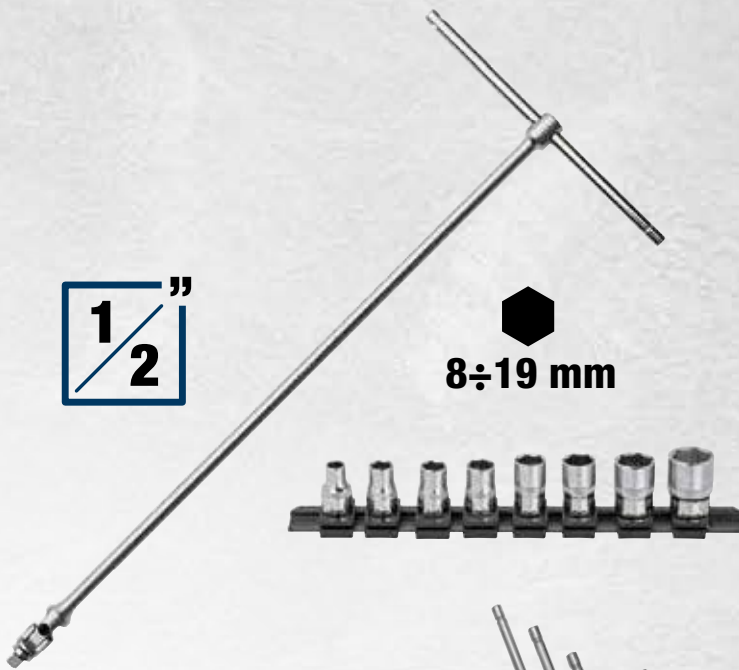

8÷19 mm



273 1/2 Q/SE9

Cod. U02730205



9
PEZZI

Chiave a T snodata con 8 bussole esagonali

- 235 1/2 EN 8-10-11-12-13-14-17-19 mm
- 273 1/2 Q

~~€ 89,07~~

€ 62,00

8÷19 mm

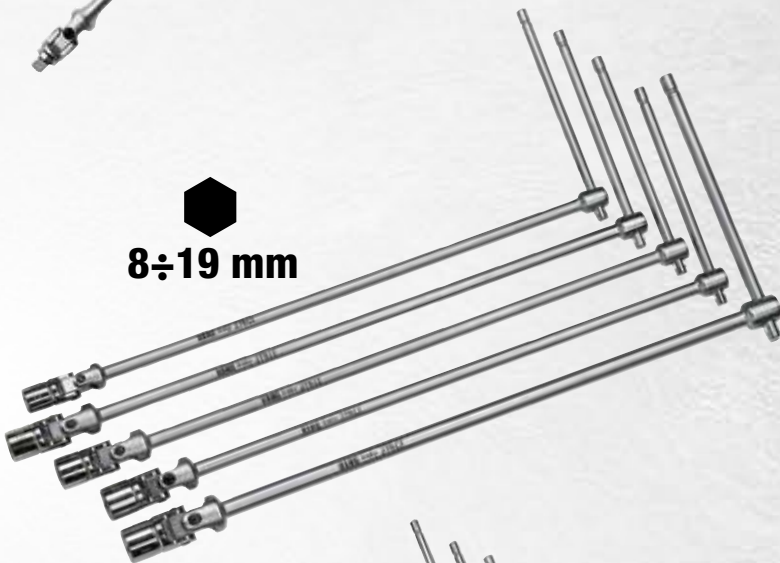

276 CE/SE5

Cod. U02760483



5
PEZZI

Serie di 5 chiavi a T snodate

- 276 CE/8-10-13-17-19 mm

~~€ 151,40~~

€ 111,00

7÷19 mm

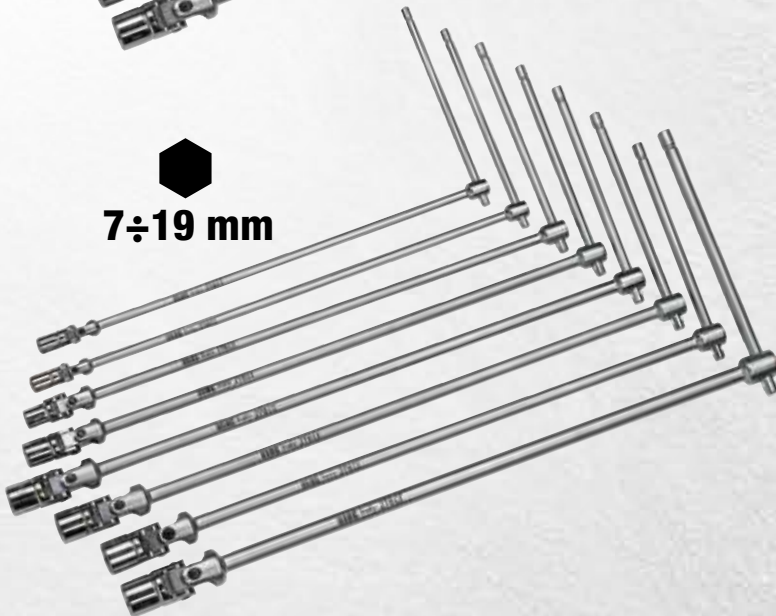

276 CE/SE8

Cod. U02760484



8
PEZZI

Serie di 8 chiavi a T snodate

- 276 CE/7-8-10-12-13-14-17-19 mm

~~€ 228,90~~

€ 160,00



LO SNODO CARDANICO USAG

- Molla di frizione interna per il perfetto preposizionamento della bussola.
- Bussola e cardano fissati con un perno in acciaio ribadito per la massima affidabilità.
- Chiavi progettate e prodotte rispettando la normativa UNI 6743.

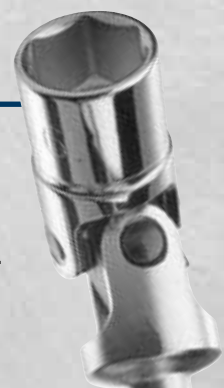

294 AD

CHIAVE A RULLINO CON REGOLAZIONE RAPIDA



YouTube

NEW

DOPPIA SCALA
millimetri/pollici

ASOLA
DI AGGANCIAMENTO

APERTURA
MAGGIORATA
+20%



ARRETRI IL RULLINO,
REGOLI RAPIDAMENTE.

RUOTI IL RULLINO,
REGOLI CON PRECISIONE.

294 AD

Chiavi a rullino con regolazione rapida

- Si regola rapidamente arretrando il rullino
- Grande capacità: apertura +15% rispetto allo standard
- Doppia scala graduata: millimetri e pollici
- Testa inclinata di 22°
- Rullino in acciaio
- Asola di aggancio
- Finitura cromata

CODICE	L	APERTURA	€	€
U02940011	110 mm - 4"	17 mm	€ 16,50	€ 11,60
U02940012	150 mm - 6"	23 mm	€ 17,30	€ 12,10
U02940013	200 mm - 8"	33 mm	€ 20,70	€ 14,50
U02940014	250 mm - 10"	38 mm	€ 26,30	€ 18,40
U02940015	300 mm - 12"	41 mm	€ 34,60	€ 24,20
U02940016	380 mm - 15"	50 mm	€ 63,50	€ 44,50
U02940017	460 mm - 18"	63 mm	€ 104,00	€ 72,80

294 AG

CHIAVE A RULLINO REVERSIBILE



YouTube



**INVERTI LA
GANASCIA MOBILE
PER PASSARE DALLA
PRESA SU ESAGONO A
QUELLA SU TONDO**

294 AG

Chiavi a rullino reversibili con impugnatura

- Nella posizione standard può manovrare un profilo esagonale
- Invertendo il dente mobile, può manovrare un profilo tondo
- Grande capacità: apertura +15% rispetto allo standard
- Doppia scala graduata: millimetri e pollici
- Impugnatura ergonomica bimateriale
- Testa inclinata di 22°
- Rullino in acciaio
- Asola di aggancio
- Finitura cromata

CODICE	L	APERTURA	€ 22,70	€ 15,90
U02940023	200 mm - 8"	33 mm	€ 22,70	€ 15,90
U02940024	250 mm - 10"	38 mm	€ 28,90	€ 20,20
U02940025	300 mm - 12"	41 mm	€ 38,00	€ 26,60

Cassette di bussole

YouTube



Just **USAG**



1/2"

1/4"



601 1/4-1/2 J100

Cod. U06010011



100 PEZZI

Assortimento in cassetta modulare con bussole esagonali ed inserti per avvitatura

~~€ 175,00~~

€ 115,00

8 kg | 415 mm | 92 | 283



MODULARE CON I CASSETTI DEI CARRELLI USAG!



DESCRIZIONE	MISURA	PZ.
Chiavi a bussola 1/4" con bocca esagonale	4-4,5-5,5-6-7-8-9-10-11-12-13-14 mm	12
Chiavi a bussola 1/4" lunghe con bocca esagonale	6-8-10-11-12-13-14 mm	7
Chiavi a bussola 1/4" con bocca TORX®	E6-E8-E10	3
Chiavi a bussola 1/4" con inserto a croce PH	1-2	2
Chiavi a bussola 1/4" con inserto a croce PZ	1-2	2
Chiavi a bussola 1/4" con inserto ad intaglio	0,6x4-1,2x7	2
Chiavi a bussola 1/4" con inserto esagonale maschio	3-4-5-6	4
Chiavi a bussola 1/4" con inserto TORX®	T8-T10-T15-T20-T25-T27-T30	7
Prolunghe 1/4"	50-100 mm	2
Snodo cardanico 1/4"		1
Leva a T 1/4"		1
Impugnatura porta-bussole 1/4"		1
Cricchetto reversibile 1/4"		1

DESCRIZIONE	MISURA	PZ.
Chiavi a bussola 1/2" con bocca esagonale	10-11-12-13-14-15-16-17-18-19-20-21-22-24-27-30-32 mm	17
Chiavi a bussola 1/2" lunghe con bocca esagonale	13-14-15-17-19-22 mm	6
Chiavi a bussola 1/2" con bocca TORX®	E12-E14-E16-E18-E20-E24	6
Chiavi a bussola 1/2" per candele	16-21 mm	2
Prolunghe 1/2"	130-250 mm	2
Snodo cardanico 1/2"		1
Cricchetto reversibile 1/2"		1
Riduttore	1/2"-3/8"	1
Chiave a bussola portainseri	1/2"-5/16"	1
Inserti 5/16" ad intaglio	8-12	2
Inserti 5/16" a croce PH	3-4	2
Inserti 5/16" a croce PZ	3-4	2
Inserti 5/16" TORX®	T40-T45-T50-T55	4
Inserti 5/16" esagonali maschio	8-10-12-14 mm	4
Inserti 5/16" XZN	6-8-10-12	4

LA QUALITÀ **USAG** A UN PREZZO *Just*



1 kg | mm | 190
58
144

601 1/4-1/2 JTX16

Cod. U06010009



16
PEZZI

Assortimento in cassetta modulare con bussole TORX®

DESCRIZIONE	MISURA	PZ.
Chiavi a bussola 1/4 TORX®	E6-E7-E8-E10	4
Chiavi a bussola 1/2 TORX®	E12-E14-E16-E18	4
Chiavi a bussola 1/4 con inserto TORX®	T10-T15-T20-T25	4
Chiavi a bussola 1/2 con inserto TORX®	T30-T40-T45-T50	4

~~€ 37,30~~

€ 26,00

601 1/4 J34

Cod. U06010001



34
PEZZI

Assortimento in cassetta modulare con bussole esagonali ed inserti per avvitatura

DESCRIZIONE	MISURA	PZ.
Chiavi a bussola 1/4"	4-4,5-5-5,5-6-7-8-9-10-11-12-13-14	13
Cricchetto reversibile 1/4"		1
Snodo cardanico 1/4"		1
Prolunghe 1/4"	55-100	2
Inserti a intaglio	4-5,5-6	3
Inserti a croce POZIDRIV®	1-2-3	3
Inserti esagono maschio	4-5-6	3
Inserti TORX®	T10-T15-T20-T25-T30-T40	6
Impugnatura maschio/femmina		1
Raccordo portainseriti 1/4"		1

~~€ 71,50~~

€ 46,50



1 kg | mm | 190
58
144



601 1/2 J22

Cod. U06010003



22
PEZZI

Assortimento in cassetta modulare con bussole esagonali

DESCRIZIONE	MISURA	PZ.
Bussole esagonali 1/2"	8-10-11-12-13-14-15-16-17-18-19-21-22-24-27-30-32	17
Cricchetto 1/2"		1
Prolunghe 1/2"	130-250	2
Snodo cardanico 1/2"		1
Leva a T 1/2"		1

~~€ 105,00~~

€ 68,00



4 kg | mm | 375
80
186

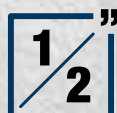

237 A

CRICCHETTO REVERSIBILE CON MECCANISMO SIGILLATO IP51



Sistema di inversione integrato nel coperchio



Spessore della testa ridotto rispetto ai modelli standard -10%



IP51
PROTEZIONE DA
POLVERE E ACQUA

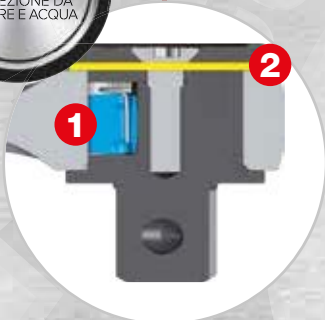

1. Nottolino brevettato
2. Diaframma protettivo



YouTube



IMPUGNATURA CONICA
in bimateriale e antiscivolo



TOP PERFORMANCE

1. Resistenza alla torsione statica:
+30% di coppia rispetto alla norma ISO 3315 grazie al nottolino brevettato.
2. Resistenza a fatica:
dura il doppio dei normali cricchetti del mercato grazie alla protezione IP51.

$\frac{1}{4}$ "

237 A 1/4"

Cod. U02370102

Cricchetto reversibile 1/4"

~~€ 31,10~~

€ 21,80

$\frac{3}{8}$ "

237 A 3/8"

Cod. U02370104

Cricchetto reversibile 3/8"

~~€ 36,30~~

€ 25,40

$\frac{1}{2}$ "

237 A 1/2"

Cod. U02370106

Cricchetto reversibile 1/2"

~~€ 41,50~~

€ 29,10



606 1/4" EA

Cod. U06060101



19
PEZZI

Assortimento in cassetta di ABS con bussole esagonali

- Cassetta in ABS ad alta resistenza con sistema di chiusura rapida

DESCRIZIONE	ART./MISURA	PZ.
Chiavi a bussola con bocca esagonale	235 1/4 EN 4-4,5-5-5,5-6-7-8-9-10-11-12-13-14	13
Prolunghe	236 1/4 50-100	2
Snodo cardanico	241 1/4	1
Leva a T con attacco quadro scorrevole	240 1/4 N	1
Portabussole con impugnatura	243 1/4	1
Cricchetto reversibile certificato IP51	237 A 1/4	1

~~€ 109,33~~

€ 69,00



605 3/8" EA

Cod. U06050206



20
PEZZI

Assortimento in cassetta di ABS con bussole esagonali

- Cassetta in ABS ad alta resistenza con sistema di chiusura rapida

DESCRIZIONE	ART./MISURA	PZ.
Chiavi a bussola con bocca esagonale	235 3/8 E 7-8-9-10-11-12-13-14-15-16-17-18-19-21-22	15
Prolunghe	236 3/8 125-250	2
Leva a T con attacco quadro scorrevole	240 3/8 N	1
Snodo cardanico	241 3/8	1
Cricchetto reversibile certificato IP51	237 A 3/8	1

~~€ 173,32~~

€ 121,00



606 1/2" EA

Cod. U06060302



23
PEZZI

Assortimento in cassetta di ABS con bussole esagonali

- Cassetta in ABS ad alta resistenza con sistema di chiusura rapida

DESCRIZIONE	ART./MISURA	PZ.
Chiavi a bussola con bocca esagonale	235 1/2 EN 8-9-10-11-12-13-14-15-16-17-18-19-21-22-23-24-27-30-32	19
Prolunghe	236 1/2 125-250	2
Snodo cardanico	241 1/2	1
Cricchetto reversibile certificato IP51	237 A 1/2	1

~~€ 211,43~~

€ 129,00

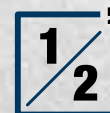

Cassette di bussole

BUSSOLE IN MILLIMETRI E POLLICI



NEW



612 1/2" MPA

Cod. U06122014



35
PEZZI

Assortimento in cassetta di lamiera con bussole poligonali

DESCRIZIONE	ART./MISURA	PZ.
Chiavi a bussola con bocca poligonale	235 1/2 N 10-11-12-13-14-15-16-17-18-19-22-24-27-30-32	15
Chiavi a bussola in pollici con bocca poligonale	235 1/2 PN 3/8-7/16-1/2-9/16-5/8-11/16-3/4-13/16-7/8-15/16-1-1 1/16-1 1/8-1 3/16-1 1/4	15
Prolunghe	236 1/2 125-250	2
Snodo cardanico	241 1/2	1
Leva a T scorrevole	240 1/2 N	1
Cricchetto reversibile certificato IP51	237 A 1/2	1

1/2"



~~€ 365,99~~

€ 256,00



NEW

3/4"

612 3/4" EB

Cod. U06120017



17
PEZZI

Assortimento in cassetta di lamiera con bussole esagonali

DESCRIZIONE	ART./MISURA	PZ.
Chiavi a bussola con bocca esagonale	235 3/4 N 22-23-24-26-27-28-30-32-36-38-41-46-50	13
Prolunghe	236 3/4 200-400	2
Leva a T scorrevole	240 3/4 N	1
Cricchetto reversibile con meccanismo sigillato 120 denti	237 A 1/2	1



~~€ 492,50~~

€ 345,00



NEW

1"

612 1" ESI

Cod. U06120019



12
PEZZI

Assortimento in cassetta di lamiera con bussole esagonali

DESCRIZIONE	ART./MISURA	PZ.
Chiavi a bussola con bocca esagonale	235 1 N 46-50-55-60-65-70-75-80	8
Prolunghe	236 1 200-415	2
Leva a T scorrevole	240 1 N	1
Cricchetto reversibile	237 1 SI	1



~~€ 856,30~~

€ 599,00

PRECISIONE
±4%

810 F

ISO 6789



YouTube

1/2"



Chiave dinamometrica con cricchetto reversibile a testa snodata

- Testa snodata per agevolarne l'utilizzo in spazi ridotti o profondi
- Angolo di inclinazione fino a 20°
- Scala di lettura in Nm
- Modello a coppia regolabile per serraggi destrorsi
- Riarmo automatico al rilascio dopo il disinnesto
- Fornita con certificato di collaudo

ARTICOLO	CODICE	CAPACITÀ	☑	L (mm)	RISOL.		
810 F 100	U08104013	20 ÷ 100	1/2"	447	0,25	€ 207,00	€ 135,00
810 F 200	U08104015	40 ÷ 200	1/2"	500	0,5	€ 207,00	€ 135,00

⚠ IMPORTANTE ⚠

Quando la chiave è utilizzata inclinata a +/- 20° la coppia di serraggio deve essere impostata con un incremento del +5%.
Esempio: Coppia necessaria 90 Nm = Coppia per uso inclinato 94,5 Nm

ISO 6789



1/4"

3/8"

1/2"

810 N

PRECISIONE
±4%

Chiave dinamometrica con cricchetto reversibile

- Modello a coppia regolabile per serraggi destrorsi
- Riarmo automatico al rilascio dopo il disinnesto
- Fornita con certificato di collaudo

ARTICOLO	CODICE	CAPACITÀ	☑	L (mm)	RISOL.		
810 N 5	U08104000	1÷5	1/4"	197	0,05	€ 194,00	€ 125,00
810 N 25	U08104001	5 ÷ 25	1/4"	290	0,05	€ 198,00	€ 125,00
810 N 50	U08104002	10 ÷ 50	3/8"	350	0,25	€ 198,00	€ 125,00
810 N 100	U08104003	20 ÷ 100	1/2"	410	0,25	€ 198,00	€ 125,00
810 N 200	U08104005	40 ÷ 200	1/2"	475	0,5	€ 200,00	€ 125,00
810 N 340	U08104006	68 ÷ 340	1/2"	630	1	€ 229,00	€ 149,00

ISO 6789

3/4"

812 N

PRECISIONE
±4%

Chiavi dinamometriche con cricchetto reversibile

- **812 N 600:** Modello a coppia regolabile per serraggi destrorsi e sinistrorsi con rotazione del cricchetto di 180°
- **812 N 1000:** Modello a coppia regolabile per serraggi destrorsi
- Precisione ±4% del valore di coppia impostato
- Scala di lettura in Nm
- Segnale sensitivo e sonoro al raggiungimento della coppia impostata
- Riarmo automatico al rilascio dopo il disinnesto
- Blocco di sicurezza dopo la regolazione della coppia
- Fornita in cassetta di lamiera completa di certificato di collaudo
- Cricchetto con attacco quadro 3/4"

ARTICOLO	CODICE	CAPACITÀ	☑				
812 N 600	U08120006	120 ÷ 600	3/4"			€ 911,00	€ 629,00
812 N 1000	U08120010	200 ÷ 1000	3/4"			€ 1.140,00	€ 789,00

IL MODULO TAGLIA L



CARRELLI: UN CASSETTO CONTIENE 3 MODULI L
Disponibili anche carrelli con cassette a 4 e 5 moduli

LA MODULARITÀ

IL MODULO L DI USAG È LA TAGLIA PRINCIPALE DI UN SISTEMA DI ASSORTIMENTI E DI CONTENITORI componibile a piacere.

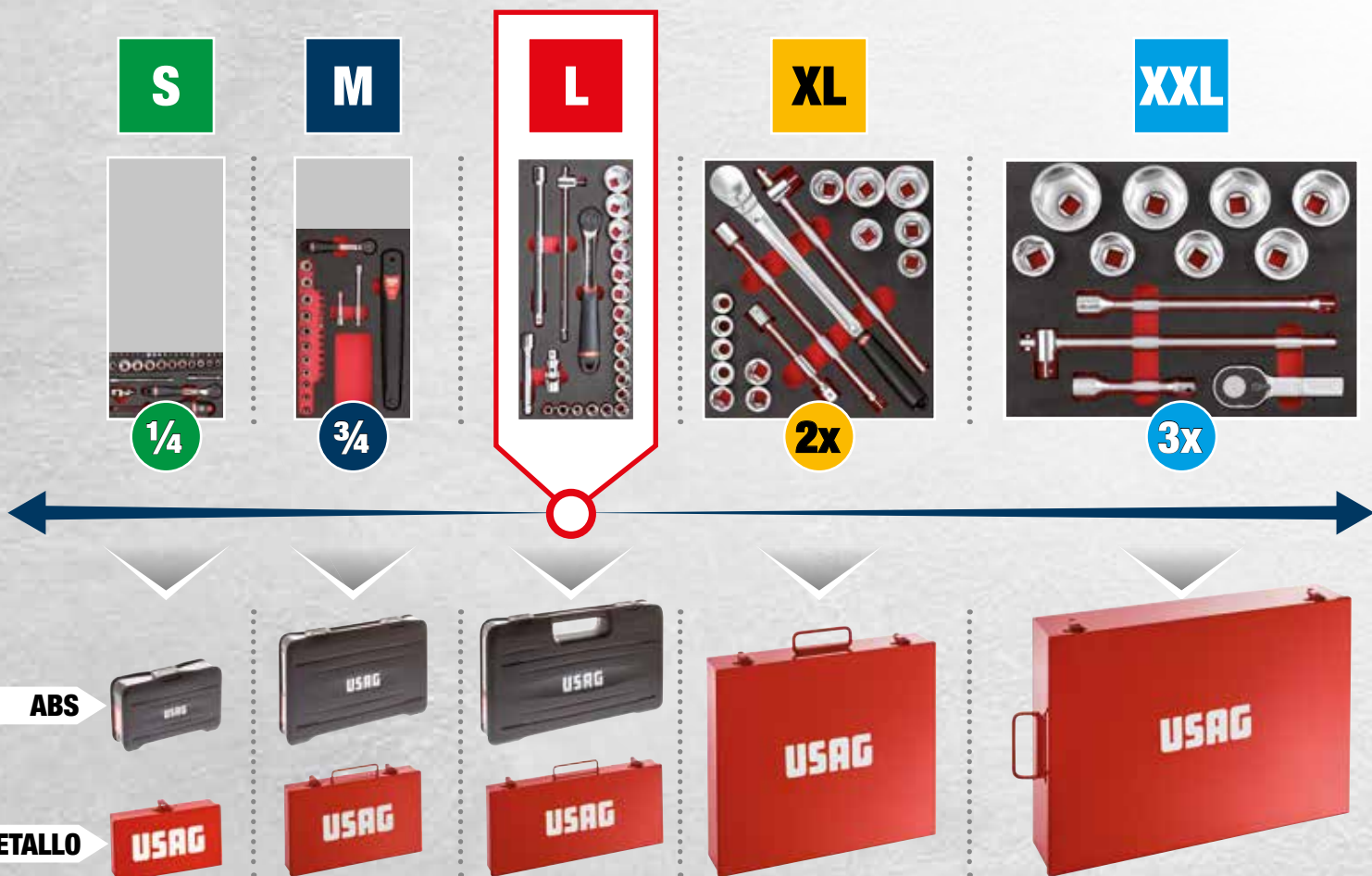

TUTTI I MODULI SONO ANCHE TRASPORTABILI NELLE CASSETTE

GAMMA MODULI IN SPUGNA BICOLORE



**VISUALIZZAZIONE IMMEDIATA
DEGLI UTENSILI MANCANTI**



519 MSK6

Cod.U05190910Q

Modulo portaminuterie

€ 20,40 **€ 14,30**



519 M 127N

Cod.U05190937

127 N 19÷60 · 127 PN 19÷60 ·
128 N 19÷60 · 128 PN 19÷60

€ 98,60 **€ 69,00**



519 M 133AX

Cod.U05191003

133 AX 160 · 135 B 250
150 AX 180 · 180 B 250

€ 168,80 **€ 118,00**



519 M 133AX1

Cod.U05191004

133 AX 160 · 180 B 250
188 AX 160 · 211 B

€ 127,00 **€ 88,90**



519 M 150AX

Cod.U05190965

133 AX 160 · 134 250 · 150 AX 180 ·
180 C 250 · 188 AX 160

€ 142,80 **€ 100,00**



519 M 233C24

Cod.U05191002

233 1/2 NS 9L-10L · 233 1/2" NTX T40L-
T45L-T55L-T70L · 233 1/2 NXZN 6L-8L-
10L-12L-14L · 234 1/2 N 6L-7L-8L-10L-12L
235 1/2 NTX E12-E14-E16-E18-E20
235 1/4 TX E8 · 235 3/8 NTX E8-E10

€ 310,28 **€ 217,00**



519 M 235M

Cod.U05191009

235 1/2 M 10-11-12-13-14-15-16-17-18-19-
22-24 · 235 1/2 MLS 15-17-19-21-22-24 ·
235 MCA 4-6 · 235 MDA 4-6

€ 257,55 **€ 180,00**



519 M 236K

Cod.U05190236

235 1/2 M 10-11-12-13-14-15-16-17-18-19-
22-24 · 236 K 1/2"

€ 235,15 **€ 164,60**



519 M 236K1

Cod.U05190238 (237 A)

235 1/4 EN 5,5-6-7-8-9-10-11-12-13-14 ·
236 1/4" 50-100 · 236 K 1/4" · 237 A 1/4" ·
660 E 3-4-5-6-7 · 660 PH 1-2-3 · 660 STX
T15-T20-T25-T30 · 684 1/4"

€ 206,41 **€ 144,50**



519 M 236K2

Cod.U05190239

235 1/2 EN 10-11-12-13-14-15-16-17-18-
19-21-22-24-27-30-32 · 236 1/2" 125 ·
236 K 1/2" · 237 A 1/2" · 241 1/2"

€ 287,02 **€ 200,90**



519 M 280N1

Cod.U05191013

280 S9 1,5-2-2,5-3-4-5-6-8-10 · 280 TX/
S8C T10-T15-T20-T25-T27-T30-T40-T45
· 692 J100

€ 112,96 **€ 79,00**



519 M 280TK

Cod.U05190935

280 TK 2,5-3-4-5-6-8

€ 100,60 **€ 70,40**

Moduli in spugna



519 M 285A1
Cod.U05190921 **17 PEZZI**
285 6-7-8-9-10-11-12-13-14-15-16-17-18-19-21-22-24
€ 153,03 **€ 109,00**



519 M 285A2
Cod.U05190943 **5 PEZZI**
285 27-29-30-32-34
€ 128,10 **€ 90,00**



519 M 285KA
Cod.U05190944 **12 PEZZI**
285 KA 8-9-10-11-12-13-14-15-16-17-18-19
€ 214,10 **€ 150,00**



519 M 285KF
Cod.U05190964 **12 PEZZI**
285 KF 8-9-10-11-12-13-14-15-16-17-18-19
€ 251,10 **€ 176,00**



519 M 291N13
Cod.U05191001 **13 PEZZI**
291 N 7-8-9-10-11-12-13-14-15-16-17-18-19
€ 213,70 **€ 149,00**



519 M 322H
Cod.U05190927 **8 PEZZI**
322 0,5x3x75-0,8x4x100-1x5,5x125-1,2x6,5x150-1,6x8x175 · 322 PH 0x75-1x100-2x125
€ 46,67 **€ 32,70**



519 M 322STX
Cod.U05190929 **6 PEZZI**
322 STX T10x75-T15x75-T20x100-T25x100-T30x125-T40x125
€ 53,26 **€ 37,30**



519 M 324H
Cod.U05190910 **8 PEZZI**
324 0,5x3x75-0,6x3,5x100-0,8x4x100-1x5,5x125-1,2x6,5x150-1,6x8x175 · 324 PH 1x100-2x125
€ 63,10 **€ 44,10**



519 M 324STX
Cod.U05190911 **7 PEZZI**
324 STX T10x75-T15x75-T20x100-T25x100-T27x100-T30x125-T4x150
€ 94,00 **€ 65,80**



519 M 333K
Cod.U05190978 **23 PEZZI**
333 K · 333 E 2,5-3-4-5-6 · 333 PH 0-1-2-3 · 333 STX T7-T8-T9-T10-T15-T20-T25-T27-T30-T40 · 333 1/4 Q · 333 1/4 MG · 660 0,6x4,5-1x5,5-1,2x6,5-1,6x8 · 660 PZ 0-1-2-3
€ 186,15 **€ 130,30**



519 M 382F
Cod.U05190926 **7 PEZZI**
362 175 · 367 2x100-3x130-6x180 · 368 3x100 · 376 28 · 382F 500
€ 103,62 **€ 72,00**



519 M 425TPMS
Cod.U05190425 **10 PEZZI**
235 1/4 EL 11-12 · 425 C · 660 Q · 664 TX T10-T15-T20 · 824 A 1,4÷10 · 824 C · FPBC.461
€ 260,00 **€ 182,00**



519 M 613AFA
Cod.U05190940 (237 A) **46 PEZZI**
235 1/4" EN 5,5-6-7-8-9-10-11-12-13-14 · 236 1/4" 50-100 · 237 A 1/4" · 240 1/4" · 241 1/4" · 243 1/4" · 280 LTS/S9 · 684 1/4"-1/4" · 660 0,6-1-1,6 · 660 E 3-4-5-6-8 · 660 PH 1-2-3 · 660 PZ 1-2-3 · 660 STX T15-T20-T25-T27-T30-T40
€ 209,42 **€ 146,00**



519 M 613AEB
Cod.U05190924 (237 B) **46 PEZZI**
235 1/4" EN 5,5-6-7-8-9-10-11-12-13-14 · 236 1/4" 50-100 · 237 B 1/4" · 240 1/4" · 241 1/4" · 243 1/4" · 280 LTS/S9 · 684 1/4"-1/4" · 660 0,6-1-1,6 · 660 E 3-4-5-6-8 · 660 PH 1-2-3 · 660 PZ 1-2-3 · 660 STX T15-T20-T25-T27-T30-T40
€ 215,32 **€ 150,00**



519 M 613BEA
Cod.U05190928 (237 A) **20 PEZZI**
235 3/8" E 7-8-9-10-11-12-13-14-15-16-17-18-19-21-22 · 236 3/8" 125-250 · 237 A 3/8" · 240 3/8" N · 241 3/8"
€ 180,32 **€ 126,00**



519 M 613BEB
Cod.U05190941 (237 B) **20 PEZZI**
235 3/8" E 7-8-9-10-11-12-13-14-15-16-17-18-19-21-22 · 236 3/8" 125-250 · 237 B 3/8" · 240 3/8" N · 241 3/8"
€ 187,82 **€ 131,00**



519 M 613CEA
Cod.U05190942 (237 A) **23 PEZZI**
235 1/2" EN 8-10-11-12-13-14-15-16-17-18-19-21-22-23-24-27-30-32 · 236 1/2" 125-250 · 237 A 1/2" · 240 1/2" N · 241 1/2"
€ 228,53 **€ 160,00**



519 M 613CEB
Cod.U05190925 (237 B) **23 PEZZI**
235 1/2" EN 8-10-11-12-13-14-15-16-17-18-19-21-22-23-24-27-30-32 · 236 1/2" 125-250 · 237 B 1/2" · 240 1/2" N · 241 1/2"
€ 238,53 **€ 167,00**



519 M 824SK11
Cod.U05190975 **11 PEZZI**
664 EL 3-4-5 · 664 IP IP15-IP20-IP25 · 664 TX T15-T20-T25 · 672 AMG · 824 A 1,4÷10
€ 221,00 **€ 155,00**

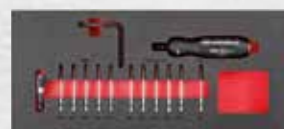

519 M 824SK13
Cod.U05190976 **13 PEZZI**
664 EL 2 · 664 IP IP6-IP8-IP9-IP10 · 664 TX T6-T7-T8-T9-T10 · 672 AMG · 824 A 0,5÷2,5
€ 221,00 **€ 155,00**



519 M 824SK23 **23 PEZZI**
Cod.U05190977

664 EL 2-3-4-5 · 664 IP IP6-IP7-IP8-IP9-IP10-IP15-IP20-IP25 · 664 TX T6-T7-T8-T9-T10-T15-T20-T25 · 672 AMG · 824 A 0,5÷2,5 · 824 A 1,4÷10

€ 415,00 **€ 290,50**



519 M 990A5B **5 PEZZI**
Cod.U05191012

990 B PA · 990 B PB · 990 B PC · 990 B PD · 990 B PE

€ 64,00 **€ 44,80**

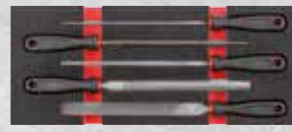

519 M 990A5MD **5 PEZZI**
Cod.U05191011

990 M PA · 990 M PB · 990 M PC · 990 M PD · 990 M PE

€ 65,50 **€ 45,80**



519 M 995K **501 PEZZI**
Cod.U05190139

995 A · 995 AL 3x8 (100) · 995 AL 3x10 (100) · 995 AL 4x10 (100) · 995 AL 4x12 (100) · 995 AL 4,8x12 (100)

€ 49,10 **€ 34,30**

MODULI CON AVVITATORI AD IMPULSI



519 M 929PC1 **1/2"**
Cod.U05191007

Avvitatore ad impulsi in magnesio 929 PC1 1/2"

€ 345,20 **€ 235,00**



519 M 942PC3 **1/2"**
Cod.U05191008

Avvitatore ad impulsi extra compatto 942 PC3 1/2"

€ 226,20 **€ 164,00**



519 M 943PC1 **1/2"**
Cod.U05191006

Avvitatore ad impulsi in magnesio con LED 943 PC1 1/2"

€ 445,20 **€ 304,00**

MODULI XL-XXL

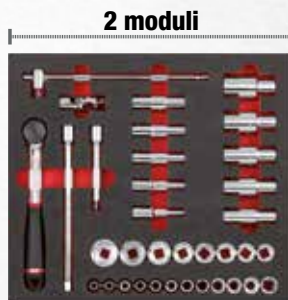

519 M 612CLA **35 PEZZI**
Cod.U05190988 (237 A)

235 1/2" LN 10-12-13-14-17-19-22-24-27-30 · 235 1/2" N 8-9-10-11-12-13-14-15-16-17-18-19-20-21-22-23-24-27-30-32 · 236 1/2" 125-250 · 237 A 1/2" · 240 1/2" N · 241 1/2"

€ 391,70 **€ 274,00**



519 M 612MPA **35 PEZZI**
Cod.U05190986 (237 A)

235 1/2" N 10-11-12-13-14-15-16-17-18-19-22-24-27-30-32 · 235 1/2" PN 3/8-7/16-1/2-9/16-5/8-11/16-3/4-13/16-7/8-15/16-1-1 1/16-1 1/8-1 3/16-1 1/4 · 236 1/2" 125-250 · 237 A 1/2" · 240 1/2" N · 241 1/2"

€ 325,99 **€ 228,00**



519 M 612EB **17 PEZZI**
Cod.U05190990 (237 B)

235 3/4" N 22-23-24-26-27-28-30-32-36-38-41-46-50 · 236 3/4" 200-400 · 237 B 3/4 · 240 3/4 N

€ 452,50 **€ 317,00**



519 M 612ESI **12 PEZZI**
Cod.U05190993

235 1" EN 46-50-55-60-65-70-75-80 · 236 1" 200-415 · 237 1" SI · 240 1" N

€ 806,30 **€ 564,00**

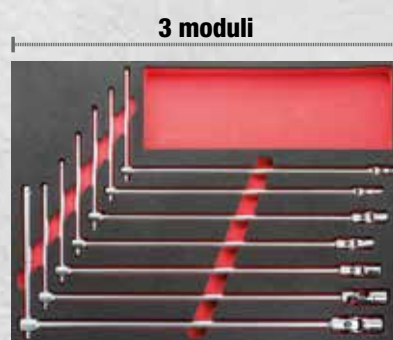

519 M 276 **7 PEZZI**
Cod.U05190936

276 CE 7-8-10-11-13-17-19

€ 210,80 **€ 155,00**

Moduli in plastica



519 SKV6

Cod.U05190827

Vaschetta portaminuterie

€ 11,60 **€ 8,10**



519/091H

Cod.U05190758

9
PEZZI

091 0,4x2,5x50-0,5x3x75 0,6x3,5x100-
0,8x4x100-1x5,5x125-1,2x6,5x150 ·
091 PH 0x75-1x100-2x125

€ 75,82 **€ 53,00**



519/127C

Cod.U05190717

4
PEZZI

127 C 19÷60 · 127 CP 19÷60 ·
128 C 19÷60 · 128 CP 19÷60

€ 79,80 **€ 55,50**



519/127N

Cod.U05190716

4
PEZZI

127 N 19÷60 · 127 PN 19÷60 ·
128 N 19÷60 · 128 PN 19÷60

€ 94,50 **€ 66,00**



519/150AX

Cod.U05190850

5
PEZZI

133 AX 160 · 134 250 · 150 AX 180 ·
180 C 250 · 188 AX 160

€ 138,70 **€ 97,10**



519/233A

Cod.U05190820

15
PEZZI

233 1/2 NS 9L-10L · 233 1/2" NTX T40L-
T45L-T55L-T70L · 233 1/2 NXZN 6L-8L-
10L-12L-14L · 234 1/2 N 5L2-6L-7L-8L

€ 242,60 **€ 170,00**



519/234C

Cod.U05190720

22
PEZZI

233 1/2" NTX T27-T30-T40-T45-T50-
T55-T60 · 234 1/2" N 5-6-7-8-10-12-
14-17 · 235 1/2" NTX E10-E12-E14-E16-
E18-E20-E24

€ 235,91 **€ 165,00**



519/235LN

Cod.U05190829

10
PEZZI

235 1/2 LN 10-11-12-13-14-15-
16-17-19-22

€ 142,40 **€ 99,70**



519/252A1

Cod.U05190821

11
PEZZI

252 N 6x7-8x9-10x11-12x13-14x15-
16x17-18x19-21x23-22x24-27x29-30x32

€ 96,87 **€ 67,80**



519/280TK

Cod.U05190787

6
PEZZI

280 TK 2,5-3-4-5-6-8

€ 96,50 **€ 67,60**



519/283

Cod.U05190899

8
PEZZI

283 N 6x7-8x9-8x10-10x11-12x13-
14x15-16x17-18x19

€ 88,99 **€ 62,00**



519/285A1

Cod.U05190785

25
PEZZI

285 6-7-8-9-10-11-12-13-14-15-16-17-
18-19-22-24 280 S9 1,5÷10

€ 156,33 **€ 111,00**



519/285B2

Cod.U05190823

4
PEZZI

285 27-29-30-32

€ 89,60 **€ 62,50**



519/285KA1

Cod.U05190788

12
PEZZI

285 KA 8-9-10-11-12-13-14-15-
16-17-18-19

€ 210,00 **€ 147,00**



519/285KF

Cod.U05190851

12
PEZZI

285 KF 8-9-10-11-12-13-14-15-
16-17-18-19

€ 247,00 **€ 173,00**



519/291NA

Cod.U05190824

10
PEZZI

291 N 8-10-11-12-13-14-16-17-18-19

€ 168,80 **€ 118,00**



519/294

Cod.U05190732

9
PEZZI

204 250 · 294 A 250 · 367 2x110-3x130-
4x145-5x165-6x180-8x200 · 981 A3

€ 103,54 **€ 72,50**



519/299

Cod.U05190760

5
PEZZI

299 6-7-8-10-13 mm

€ 78,40 **€ 55,00**



519/322H

Cod.U05190772

10
PEZZI

322 0,5x3x75-0,8x4x100-1x5,5x125-
1,2x6,5x150-1,6x8x175 · 322 PH 0x75-1x75-
2x125 · 322 N 0,8x4x30 · 322 NPH 2x30

€ 51,47 **€ 36,00**



519/322STX

Cod.U05190831

6
PEZZI

322 STX T10-T15-T20-T25-T30-T40

€ 48,96 **€ 34,30**



519/324H
Cod.U05190763 **10 PEZZI**
324 0,5x3x75-0,8x4x100-1x5,5x125-1,2x6,5x150-1,2x8x200 · 324 PH 0x75-1x75-2x100 · 324 N 0,8x4x35 · 324 NPH 2x35
€ 66,66 **€ 46,50**



519/324TX
Cod.U05190764 **9 PEZZI**
324 TX T6x50-T7x50-T8x50-T9x75 · 324 STX T10x75-T15x75-T20x100-T25x100-T30x125
€ 94,51 **€ 66,00**



519/366
Cod.U05190740 **7 PEZZI**
351 200 · 362 125-150 · 364 125 · 366 3x125 · 4x150 · 368 4x125
€ 67,45 **€ 47,20**



519/382
Cod.U05190741 **2 PEZZI**
376 35 · 382 500
€ 39,70 **€ 27,80**



519/382F
Cod.U05190742 **8 PEZZI**
362 150 · 367 2x110-3x130-4x145-5x165 · 368 4x125 · 376 35 · 382F 500
€ 85,28 **€ 59,70**



519/607AEA **44 PEZZI**
Cod.U05190790 (237 A)
235 1/4" EN 4-4,5-5-5,5-6-7-8-9-10-11-12-13-14 · 235 1/4" EL 5-6-7-8-9-10-11-12-13-14 · 236 1/4" 50-100-150 · 237 A 1/4" · 240 1/4" · 241 1/4" · 243 1/4" · 660 0,6x4,5-0,8x5,5-1x5,5-1,2x5,5 · 660 E 2,5-3-4-5-6 · 660 PH 1-2-3 · 684 1/4"-1/4" · 236 1/4" SN
€ 252,03 **€ 177,00**



519/607CA **30 PEZZI**
Cod.U05190810 (237 A)
235 1/2" N 8-9-10-11-12-13-14-15-16-17-18-19-20-21-22-23-24-26-27-28-29-30-32-34 · 236 1/2" 125-250 · 237 A 1/2" · 239 1/2" N · 240 1/2" N · 241 1/2"



519/607CEA **30 PEZZI**
Cod.U05190811 (237 A)
235 1/2" EN 8-9-10-11-12-13-14-15-16-17-18-19-20-21-22-23-24-26-27-28-29-30-32-34 · 236 1/2" 125-250 · 237 A 1/2" · 239 1/2" N · 240 1/2" N · 241 1/2"



519/607ICEA **49 PEZZI**
Cod.U05190841 (237 A)
235 1/2 EN 8-10-11-12-13-14-15-16-17-18-19-21-22-23-24-27-30-32 · 236 1/2 125-250 · 237 A 1/2 · 240 1/2 N · 241 1/2 · 661 0,8x5,5-1x6,5-1,2x8-1,6x10 · 661 E 5-6-8-10 · 661 PH 1-2-3 · 661 PZ 1-2-3 · 661 TX T27-T30-T40-T45-T50-T55 · 664 EL 5-6-7-8-10 · 684 1/2-5/16
€ 326,65 **€ 233,00**



519/613AEA **42 PEZZI**
Cod.U05190784 (237 A)
235 1/4" EN 4-4,5-5-5,5-6-7-8-9-10-11-12-13-14 · 236 1/4" 50-150 · 237 A 1/4" · 240 1/4" · 241 1/4" · 243 1/4" · 692 S11 · 692 STX/S11 · 684 1/4"-1/4"



519/613BEA **21 PEZZI**
Cod.U05190747 (237 A)
235 3/8" E 6-7-8-9-10-11-12-13-14-15-16-17-18-19-21-22 · 236 3/8" 125-250 · 237 A 3/8" · 240 3/8" N · 241 3/8"



519/613CEA **22 PEZZI**
Cod.U05190750 (237 A)
235 1/2" EN 10-11-12-13-14-15-16-17-18-19-20-21-22-24-27-30-32 · 236 1/2" 125-250 · 237 A 1/2" · 240 1/2" N · 241 1/2"



519/615AEA **52 PEZZI**
Cod.U05190837 (237 A)
235 1/4 EN 5,5-6-7-8-9-10-11-12-13-14 · 236 1/4 50-150 · 237 A 1/4 · 240 1/4 · 241 1/4 · 243 1/4 · 280 LTS/S9 · 280 LTSTX/S8 · 660 0,5x4-1x5 · 660 E 3-4-5-6-8 · 660 PH 1-2-3 · 660 PZ 1-2 · 660 STX T10-T15-T20-T25-T30-T40 · 684 1/4
€ 252,81 **€ 177,00**



519/960 **7 PEZZI**
Cod.U05190753
207 A · 220 B1 · 960 · 966 20 · 974 · 978 A 200 · 981 A 3
€ 131,33 **€ 91,50**



519/990A1 **4 PEZZI**
Cod.U05190825
990 M PA/200 · 990 M PB/200 · 990 M PC/200 · 990 M PE/200
€ 50,13 **€ 35,10**



519/990AB1 **4 PEZZI**
Cod.U05190826
990 B PA/200 · 990 B PB/200 · 990 B PC/200 · 990 B PE/200
€ 49,26 **€ 34,50**

MODULI XL-XXL



519/2001 **11 PEZZI**
Cod.U05190715
200 S · 207 A · 362 125-150 · 364 125 · 366 3x125-4x150 · 368 4x125 · 376 35 · 382 500 · 966 20
€ 138,34 **€ 96,80**

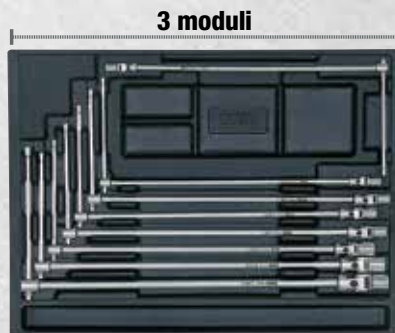

519/276 **8 PEZZI**
Cod.U05190725
276 CE 7-8-10-11-13-14-17-19
€ 234,80 **€ 166,00**



519/280T **8 PEZZI**
Cod.U05190727
280 T 2-2,5-3-4-5-6-8-10
€ 137,40 **€ 96,00**

MODULI IN SPUGNA BICOLORE



519 M 613AEA 519 M 613CEA 519 MSK6



519 M 285A1 519 M 150AX 519 MSK6



519 M 324H 519 M 324STX 519 MSK6



988 MA/S19



692 J32

495 I-SP

Cod. U04950622



157
PEZZI

Assortimento INDUSTRIA - 3 cassette

DESCRIZIONE	ART	PZ
Bussole esagonali, cricchetto (237 A 1/4"), accessori 1/4" ed inserti	519 M 613AEA	46
Bussole esagonali, cricchetto (237 A 1/2") e accessori 1/2"	519 M 613CEA	23
Chiavi combinate	519 M 285A1	17
Pinza universale, pinza regolabile, tronchese, pinza becchi lunghissimi, pinza grip	519 M 150AX	5
Giraviti a taglio e croce PH	519 M 324H	8
Giraviti TORX® Tamper Resistant	519 M 324STX	7
Assortimento di punte HSS-G	988 MA/S19	19
Assortimento di inserti con cricchetto reversibile	692 J32	32

~~€ 1.042,28~~

€ 660,00



519 M 613AEA 519 M 613CEA 519 MSK6



519 M 285A1 519 M 150AX 519 MSK6



519 M 324H 519 M 324STX 519 MSK6

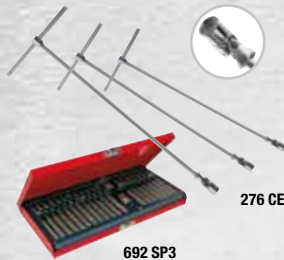

276 CE

692 SP3

495 A-SP

Cod. U04950623



149
PEZZI

Assortimento AUTORIPARAZIONE - 3 cassette

DESCRIZIONE	ART	PZ
Bussole esagonali, cricchetto (237 A 1/4"), accessori 1/4" ed inserti	519 M 613AEA	46
Bussole esagonali, cricchetto (237 A 1/2") e accessori 1/2"	519 M 613CEA	23
Chiavi combinate	519 M 285A1	17
Pinza universale, pinza regolabile, tronchese, pinza becchi lunghissimi, pinza grip	519 M 150AX	5
Giraviti a taglio e croce PH	519 M 324H	8
Giraviti TORX® Tamper Resistant	519 M 324STX	7
Assortimento di inserti RIBE con foro - XZN - TORX® Tamper Resistant	692 SP3	40
Chiavi a T snodate con bocca esagonale (10,13,17 mm)	276 CE	3

~~€ 1.100,38~~

€ 600,00

ASSORTIMENTO PER CARRELLI 4 MODULI



519 M 612CLA 519 M 613BEA 519 M 613AEA



519 M 285KA 519 M 285A1 519 M 285A2 519 M 233C24



519 M 324H 519 M 324STX 519 M 280TK 519 M 280N1



519 M 127N 519 M 150AX 519 M 382F 519 M 990A5MD

495 MA

Cod. U04950023

318
PEZZI

Assortimento MANUTENZIONE 4 cassette

~~€ 2.368,13~~

€ 1.309,00

NEW

MODULI IN PLASTICA



519/613AEA 519/613CEA 519 SK692V



519/127N 519/150AX 519 SK692V



519/322H 519/322STX 519 SK692V



519/285A1 519/990A1 519/382F

692 J32



988 MA/S19



519/613AEA 519/613CEA 519 SK692V



519/127N 519/150AX 519 SK692V



519/322H 519/285A1 519 SK692V

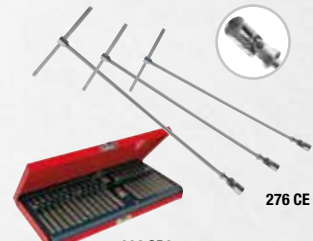

276 CE

692 SP3

495 I-PL

Cod. U04950620



177
PEZZI

Assortimento INDUSTRIA - 4 cassette

DESCRIZIONE	ART	PZ
Bussole esagonali, cricchetto (237 A 1/4"), accessori 1/4" ed inserti	519/613AEA	42
Bussole esagonali, cricchetto (237 A 1/2") e accessori 1/2"	519/613CEA	22
Pinze per anelli elastici	519/127N	4
Pinza universale, pinza regolabile, tronchese, pinza becchi lunghissimi, pinza grip	519/150AX	5
Giraviti a taglio e croce PH	519/322H	10
Giraviti TORX® Tamper Resistant	519/322STX	6
Chiavi combinate	519/285A1	25
Lima piatta, mezzotonda, tonda e triangolare	519/990A1	4
Martello, Mazzuola, Scalpelli e cacciaspine	519/382F	8
Assortimento di punte HSS-G	988 MA/S19	19
Assortimento di inserti con cricchetto reversibile	692 J32	32

~~€ 1.114,49~~

€ 604,00

495 A-PL

Cod. U04950621



149
PEZZI

Assortimento AUTORIPARAZIONE - 4 cassette

DESCRIZIONE	ART	PZ
Bussole esagonali, cricchetto (237 A 1/4"), accessori 1/4" ed inserti	519/613AEA	42
Bussole esagonali, cricchetto (237 A 1/2") e accessori 1/2"	519/613CEA	22
Pinze per anelli elastici	519/127N	4
Pinza universale, pinza regolabile, tronchese, pinza becchi lunghissimi, pinza grip	519/150AX	5
Giraviti a taglio e croce PH	519/322H	10
Chiavi combinate	519/285A1	25
Assortimento di inserti RIBE con foro - XZN - TORX® Tamper Resistant	692 SP3	40
Chiavi a T snodate con bocca esagonale (10,13,17 mm)	276 CE	3

~~€ 1.028,22~~

€ 564,00

DESCRIZIONE	ART	PZ
Bussole esagonali, cricchetto (237 A 1/4"), accessori 1/4" ed inserti	519 M 613AEA	46
Bussole esagonali, cricchetto (237 A 3/8") e accessori 3/8"	519 M 613BEA	20
Bussole esagonali, cricchetto (237 A 1/2") e accessori 1/2"	519 M 612CLA	35
Chiavi combinate 6÷24 mm	519 M 285A1	17
Chiavi combinate 27÷34 mm	519 M 285A2	5
Chiavi combinate a cricchetto reversibile 8÷19 mm	519 M 285KA	12
Chiavi a bussola TORX® e con inserto TORX®, XZN, esagonale, Ribe	519 M 233 C24	24
Giraviti a taglio e croce PH	519 M 324H	8

DESCRIZIONE	ART	PZ
Giraviti TORX® Tamper Resistant	519 M 324STX	7
Chiavi maschio a T con traversino scorrevole 2,5÷8 mm	519 M 280TK	6
Cassetta inserti assortita e chiavi maschio esagonali - TORX®	519 M 280N1	117
Pinze per anelli elastici interni ed esterni 19÷60	519 M 127N	4
Pinza universale, pinza regolabile, tronchese, pinza becchi lunghissimi, pinza grip	519 M 150AX	5
Lime a taglio mezzodolce	519 M 990A5MD	5
Martello per meccanici, mazzuola, cacciaspine, scalpello e bulino	519 M 382F	7

Valigia per manutenzione

NEW

002 JMA

Cod. U00020011

181

PEZZI

11 kg | 460 mm | 158 mm | 385 mm

Valigia con assortimento per manutenzione

- Valigia con struttura in profilato di Alluminio
- Doppia cerniera di chiusura in metallo con serratura
- 3 pannelli portautensili interni con elastici di tenuta
- Base con interno in mousse bicolore sagomata

~~€ 615,00~~

€ 359,00



CONTIENE LE PINZE SERIE AX, I NUOVI GIRAVITI 324 E LA NUOVA 294 AD!

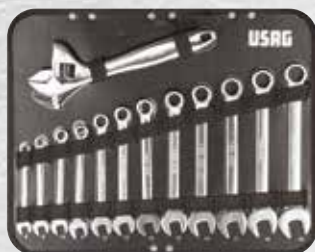

DESCRIZIONE	MISURA	PZ.
Chiavi a bussola 1/2" con bocca esagonale	10-11-12-13-14-15-16-17-18-19-21-22-24-27-30-32 mm	16
Chiavi a bussola 1/4" con bocca esagonale	4-4,5-5-5,5-6-7-8-9-10-11-12-13-14 mm	13
Prolunghe 1/2"	130-250 mm	2
Prolunghe 1/4"	55-100 mm	2
Cricchetto reversibile 1/2"		1
Cricchetto reversibile 1/4"		1
Impugnatura porta bussola 1/4"		1
Snodo cardanico 1/2"		1
Snodo cardanico 1/4"		1
Bussola portainseri	1/4-1/4"	1
Chiavi combinate	8-9-10-11-12-13-14-15-16-17-18-19 mm	12
Chiave a rullino	250 mm	1
Giraviti ad intaglio	0,4x2,5x50-0,5x3x75-0,8x4x100-1x5,5x125-1,2x6,5x150-1,6x8x175	6
Giraviti a croce PHILLIPS®	1x75-2x125	2
Giraviti a croce POZIDRIV-SUPADRIV®	1x75-2x125	2
Chiavi maschio esagonali	1,5-2-2,5-3-4-5-6-8-10 mm	9
Pinza universale	180 mm	1
Pinza regolabile	250 mm	1
Pinza a becchi mezzotondi	160 mm	1
Tronchese a taglio diagonale	160 mm	1

DESCRIZIONE	MISURA	PZ.
Giravite cercafase		1
Forbice da elettricista		1
Cutter multiuso		1
Flessometro	3 m	1
Mini seghetto		1
Martello da meccanico	300 g	1
Inseri ad intaglio	3-4-4,5-5-5,5-6-6,5-7-8	9
Inseri a croce PHILLIPS®	00-0-1(x2)-2(x2)-3-4	8
Inseri a croce POZIDRIV-SUPADRIV®	1-2(x2)-3-4	5
Inseri esagonali maschio	1,5-2-2,5-3-4-5-5,5-6-7-8 mm	10
Inseri esagonali maschio	1/16-5/64-3/32-7/64-1/8-9/64-5/32-3/16-7/32-1/4	10
Inseri TORX®	T8-T9-T10-T15-T20-T25-T27-T30-T40-T45	10
Inseri TORX® Tamper Resistant	T8-T10-T15-T20-T25-T27-T30-T35-T45	9
Inseri Tri-Wing	1-2-3-4	4
Inseri Spanner	4-6-8-10-12	5
Inseri Torq-set	6-8-10	3
Inseri quadrati	0-1-2(x2)-3	5
Inseri Clutch	1/8-5/32-3/16-1/4-5/16	5
Inseri per viti con impronta XZN	M5-M6-M8	3
Inseri esagonali maschio con foro	2-2,5-3-4-5-6	6
Inseri esagonali maschio con foro	5/64-3/32-7/64-1/8-9/64-5/32	6
Prolunghe magnetiche	1/4"	2

NEW

002 JTMA

Cod. U00020015

181
PEZZI

Valigia trolley con assortimento per manutenzione

- Valigia con struttura in profilato di Alluminio
- Doppia cerniera di chiusura in metallo con serratura
- 3 pannelli portautensili interni con elastici di tenuta
- Base con interno in mousse bicolore sagomata

~~€ 620,00~~

€ 379,00



**RUOTE INTEGRATE
NELLA STRUTTURA**

11 kg 470 mm 200 mm 370 mm

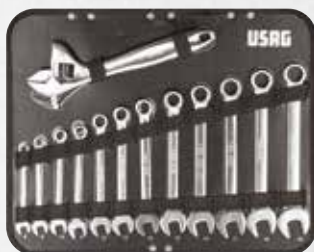

DESCRIZIONE	MISURA	PZ.
Chiavi a bussola 1/2" con bocca esagonale	10-11-12-13-14-15-16-17-18-19-21-22-24-27-30-32 mm	16
Chiavi a bussola 1/4" con bocca esagonale	4-4,5-5-5,5-6-7-8-9-10-11-12-13-14 mm	13
Prolunghe 1/2"	130-250 mm	2
Prolunghe 1/4"	55-100 mm	2
Cricchetto reversibile 1/2"		1
Cricchetto reversibile 1/4"		1
Impugnatura porta bussole 1/4"		1
Snodo cardanico 1/2"		1
Snodo cardanico 1/4"		1
Bussola portainseriti	1/4-1/4"	1
Chiavi combinate	8-9-10-11-12-13-14-15-16-17-18-19 mm	12
Chiave a rullino	250 mm	1
Giraviti ad intaglio	0,4x2,5x50-0,5x3x75-0,8x4x100-1x5,5x125-1,2x6,5x150-1,6x8x175	6
Giraviti a croce PHILLIPS®	1x75-2x125	2
Giraviti a croce POZIDRIV-SUPADRIV®	1x75-2x125	2
Chiavi maschio esagonali	1,5-2-2,5-3-4-5-6-8-10 mm	9
Pinza universale	180 mm	1
Pinza regolabile	250 mm	1
Pinza a becchi mezzotondi	160 mm	1
Tronchese a taglio diagonale	160 mm	1
Giravite cercafase		1

DESCRIZIONE	MISURA	PZ.
Forbice da elettricista		1
Cutter multiuso		1
Flessometro	3 m	1
Mini seghetto		1
Martello da meccanico	300 g	1
Inseriti ad intaglio	3-4-4,5-5-5,5-6-6,5-7-8	9
Inseriti a croce PHILLIPS®	00-0-1(x2)-2(x2)-3-4	8
Inseriti a croce POZIDRIV-SUPADRIV®	1-2(x2)-3-4	5
Inseriti esagonali maschio	1,5-2-2,5-3-4-5-5,5-6-7-8 mm	10
Inseriti esagonali maschio	1/16-5/64-3/32-7/64-1/8-9/64-5/32-3/16-7/32-1/4	10
Inseriti TORX®	T8-T9-T10-T15-T20-T25-T27-T30-T40-T45	10
Inseriti TORX® Tamper Resistant	T8-T10-T15-T20-T25-T27-T30-T35-T45	9
Inseriti Tri-Wing	1-2-3-4	4
Inseriti Spanner	4-6-8-10-12	5
Inseriti Torq-set	6-8-10	3
Inseriti quadrati	0-1-2(x2)-3	5
Inseriti Clutch	1/8-5/32-3/16-1/4-5/16	5
Inseriti per viti con impronta XZN	M5-M6-M8	3
Inseriti esagonali maschio con foro	2-2,5-3-4-5-6	6
Inseriti esagonali maschio con foro	5/64-3/32-7/64-1/8-9/64-5/32	6
Prolunghe magnetiche	1/4"	2



**MANIGLIE CASSETTI
IN ALLUMINIO**

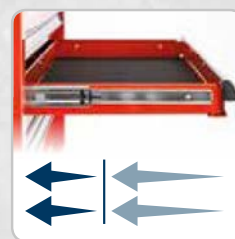

**GUIDE CON SISTEMA
DI RICHIAMO A
FINECORSA**

531 C

Cod. U05310003

6
CASSETTI

Cassettiera portatile (vuota)

- Dimensioni interne:
 - vano superiore 690x320x60 mm
 - 2 cassetti 570x270x40 mm
 - 1 cassetto 570x270x60 mm
 - 3 cassetti 165x270x40 mm



~~€ 408,00~~

€ 285,00



532

Baule portautensili (vuoto)

- Apertura ad arresto a 95°
- Gancio per chiusura a lucchetto
- Struttura in lamiera di acciaio, spessore 1,2 mm

	CODICE	L (mm)	P (mm)	H (mm)	🏋️		
A	U05320005	520	290	290	6,8 kg	€ 111,00	€ 77,70
B	U05320006	650	350	350	12,5 kg	€ 135,00	€ 94,00
C	U05320007	850	350	350	16 kg	€ 137,00	€ 96,00
D	U05320008	1000	400	450	19 kg	€ 179,00	€ 126,00



646/5LV

Cod. U06460301

5
SCOMPARTI

Cassetta estensibile LUNGA (vuota)

- Dimensioni interne:
 - vano 537x207x102 mm
 - scomparti 537x103x52 mm

~~€ 57,50~~

€ 40,30

YouTube



2,5 kg
mm
↔ 420
↓ 340
↗ 240



Tutta l'attrezzatura a portata di mano

007/1V

Cod. U00070001



Borsa professionale portautensili (vuota)

- Nylon ad altissima resistenza
- Base rigida e resistente all'acqua
- Pratici e comodi vani interni portautensili
- Due tasche frontali portaminuteria
- Pratico maniglione in alluminio
- Ganci interni porta flessometro ed elastici portautensili
- Mantella di chiusura tramite velcro

~~€ 65,50~~

€ 48,00



1,8 kg
mm
↔ 460
↓ 350
↗ 160



Tasche interne portautensili.
Apertura frontale per rapido accesso agli utensili

007 RV

Cod. U00070033



Borsa per utensili e PC (vuota)

- Nylon ad altissima resistenza.
- Base rigida rinforzata.
- 14 tasche, 2 cinghie portautensili e 1 gancio porta flessometro.
- Tracolla amovibile per un comfort extra nel trasporto.
- Chiusura tramite fibbie a scatto con sgancio rapido.

~~€ 56,00~~

€ 39,00



Compatibile con

TSTAK™

STANLEY: FMST1-71968

DeWALT: DWST1-70705

900 g
mm
↔ 340
↓ 235
↗ 90

NEW

007 FTSV

Cod. U00070060

Borsa portautensili pieghevole (vuota)

- Tessuto ad altissima resistenza
- 8 pratici e comodi vani portautensili
- Pannello centrale con elastici portautensili in entrambi i lati
- Asole porta martello
- Maniglia superiore con rivestimento in gomma
- Cinghia posteriore per fissare la borsa al trolley
- Possibilità di essere utilizzata con tracolla (non inclusa)
- Codice tracolla: U00070001Q

~~€ 30,00~~

€ 21,00



8 pratici vani
e 6 elastici portautensili



Cinghia posteriore
per fissare la borsa
al trolley

START⁵¹⁶



516 SP7V

Cod. U05160007

7
CASSETTI

3
MODULI

Carrello START (vuoto)

- Dimensioni interne:
 - 5 cassetti 570x420x60 mm
 - 1 cassetto 570x420x130 mm
 - 1 cassetto 570x420x200 mm

~~€ 673,00~~

€ 435,00



MANIGLIE BASCULANTI IN ABS



516 SP6V

Cod. U05160006

6
CASSETTI

3
MODULI

Carrello START (vuoto)

- Dimensioni interne:
 - 3 cassetti 570x420x60 mm
 - 2 cassetti 570x420x130 mm
 - 1 cassetto 570x420x200 mm

~~€ 591,00~~

€ 395,00



RISPARMIA IL TUO TEMPO

Tutti i carrelli a cassettera USAG sono subito pronti all'uso, perchè forniti con le ruote già montate alla struttura.





RISPARMI
€ 100

Rispetto all'acquisto di carrello ed assortimento separati

516 SP6I-P

Cod. U05168020



177
PEZZI

Carrello START con assortimento MANUTENZIONE - 4 cassetti

~~€ 1.705,49~~ **€ 899,00**



RISPARMI
€ 100

Rispetto all'acquisto di carrello ed assortimento separati

516 SP6A-P

Cod. U05168021



151
PEZZI

Carrello START con assortimento AUTORIPARAZIONE - 3 cassetti

~~€ 1.619,22~~ **€ 859,00**

ASSORTIMENTO MANUTENZIONE



519/613AEA 519/613CEA 519 SK692V 519/127N 519/150AX 519 SK692V



519/322H 519/322STX 519 SK692V 519/285A1 519/990A1 519/382F

692 J32



988 MA/S19



ASSORTIMENTO AUTORIPARAZIONE



519/613AEA 519/613CEA 519 SK692V 519/127N 519/150AX 519 SK692V



519/322H 519/285A1 519 SK692V

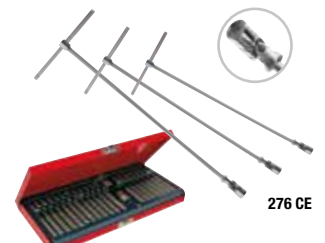

692 SP3

276 CE

DESCRIZIONE	ART	PZ
Bussole esagonali, cricchetto (237 A 1/4"), accessori 1/4" ed inserti	519/613AEA	42
Bussole esagonali, cricchetto (237 A 1/2") e accessori 1/2"	519/613CEA	22
Pinze per anelli elastici	519/127N	4
Pinza universale, pinza regolabile, tronchese, pinza becchi lunghissimi, pinza grip	519/150AX	5
Giraviti a taglio e croce PH	519/322H	10
Giraviti TORX® Tamper Resistant	519/322STX	6
Chiavi combinate	519/285A1	25
Lima piatta, mezzotonda, tonda e triangolare	519/990A1	4
Martello, Mazzuola, Scalpelli e cacciaspine	519/382F	8
Assortimento di punte HSS-G	988 MA/S19	19
Assortimento di inserti con cricchetto reversibile	692 J32	32

DESCRIZIONE	ART	PZ
Bussole esagonali, cricchetto (237 A 1/4"), accessori 1/4" ed inserti	519/613AEA	42
Bussole esagonali, cricchetto (237 A 1/2") e accessori 1/2"	519/613CEA	22
Pinze per anelli elastici	519/127N	4
Pinza universale, pinza regolabile, tronchese, pinza becchi lunghissimi, pinza grip	519/150AX	5
Giraviti a taglio e croce PH	519/322H	10
Chiavi combinate	519/285A1	25
Assortimento di inserti RIBE con foro - XZN - TORX® Tamper Resistant	692 SP3	40
Chiavi a T snodate con bocca esagonale (10,13,17 mm)	276 CE	3

Vuoi solo l'assortimento? Vai a pagina 41

NUOVO CARRELLO 516 EXTRA-LARGE

SERRATURA POSTERIORE
per evitare rotture accidentali

800 kg

PIANO DI LAVORO IN ABS
AD ALTA RESISTENZA
con doppia maniglia integrata

NEW

MANIGLIE
BASCULANTI IN ABS



PORTAFLACONI



RUOTE

in gomma antiolio
Ø 125 mm

969 mm

90 kg | mm | 969
971
517

516 SP6XLV

Cod. U05160011

6

CASSETTI

4

MODULI

Carrello Start XL (vuoto)

- Dimensioni interne cassetti:
 - 4 cassetti 760x420x60 mm
 - 1 cassetto 760x420x130 mm
 - 1 cassetto 760x420x270 mm

~~€ 729,00~~

€ 490,00

START 516



RISPARMI
€ 200

Rispetto all'acquisto di carrello ed assortimento separati

516 SP6XLM

Cod. U05160111

318
PEZZI

Carrello START XL con assortimento MANUTENZIONE - 4 cassette

~~€ 3.097,13~~

€ 1.599,00

ASSORTIMENTO MANUTENZIONE



519 M 612CLA

519 M 613BEA

519 M 613AEA



519 M 285KA

519 M 285A1

519 M 285A2

519 M 233C24



519 M 324H

519 M 324STX

519 M 280TK

519 M 280N1



519 M 127N

519 M 150AX

519 M 382F

519 M 990A5MD

DESCRIZIONE	ART	PZ
Bussole esagonali, cricchetto (237 A 1/4"), accessori 1/4" ed inserti	519 M 613AEA	46
Bussole esagonali, cricchetto (237 A 3/8") e accessori 3/8"	519 M 613BEA	20
Bussole esagonali, cricchetto (237 A 1/2") e accessori 1/2"	519 M 612CLA	35
Chiavi combinate 6÷24 mm	519 M 285A1	17
Chiavi combinate 27÷34 mm	519 M 285A2	5
Chiavi combinate a cricchetto reversibile 8÷19 mm	519 M 285KA	12
Chiavi a bussola TORX® e con inserto TORX®, XZN, esagonale, Ribe	519 M 233 C24	24
Giraviti a taglio e croce PH	519 M 324H	8

DESCRIZIONE	ART	PZ
Giraviti TORX® Tamper Resistant	519 M 324STX	7
Chiavi maschio a T con traversino scorrevole 2,5÷8 mm	519 M 280TK	6
Cassetta inserti assortita e chiavi maschio esagonali - TORX®	519 M 280N1	117
Pinze per anelli elastici interni ed esterni 19÷60	519 M 127N	4
Pinza universale, pinza regolabile, tronchese, pinza becchi lunghissimi, pinza grip	519 M 150AX	5
Lime a taglio mezzodolce	519 M 990A5MD	5
Martello per meccanici, mazzuola, cacciaspine, scalpello e bulino	519 M 382F	7

Vuoi solo l'assortimento? Vai a pagina 40

SPRINT⁵¹⁸



518 SP7V

Cod. U05180107

7
CASSETTI

3
MODULI

Carrello SPRINT (vuoto)

- Dimensioni interne:
 - 5 cassetti 570x420x60 mm
 - 1 cassetto 570x420x130 mm
 - 1 cassetto 570x420x200 mm

~~€ 805,00~~

€ 549,00



**MANIGLIE FISSE
IN ALLUMINIO ANODIZZATO**



518 SP6V

Cod. U05180106

6
CASSETTI

3
MODULI

Carrello SPRINT (vuoto)

- Dimensioni interne:
 - 4 cassetti 570x420x60 mm
 - 1 cassetto 570x420x130 mm
 - 1 cassetto 570x420x270 mm

~~€ 713,00~~

€ 499,00



RISPARMIA IL TUO TEMPO

Tutti i carrelli a cassettera USAG sono subito pronti all'uso, perchè forniti con le ruote già montate alla struttura.





RISPARMI
€ 180

Rispetto all'acquisto di carrello ed assortimento separati

518 SP6I-S

Cod. U05188022



157
PEZZI

Carrello SPRINT con assortimento MANUTENZIONE - 3 cassetti

~~€ 1.928,68~~ **€ 979,00**



RISPARMI
€ 180

Rispetto all'acquisto di carrello ed assortimento separati

518 SP6A-S

Cod. U05188023



149
PEZZI

Carrello SPRINT con assortimento AUTORIPARAZIONE - 3 cassetti

~~€ 1.986,78~~ **€ 919,00**

ASSORTIMENTO MANUTENZIONE



ASSORTIMENTO AUTORIPARAZIONE

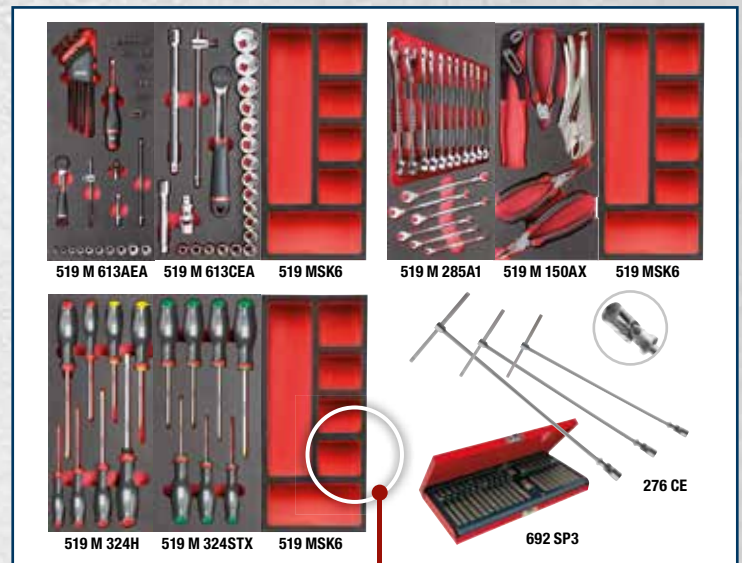

MODULI IN SPUGNA BICOLORE

DESCRIZIONE	ART	PZ
Bussole esagonali, cricchetto (237 A 1/4"), accessori 1/4" ed inserti	519 M 613AEA	46
Bussole esagonali, cricchetto (237 A 1/2") e accessori 1/2"	519 M 613CEA	23
Chiavi combinate	519 M 285A1	17
Pinza universale, pinza regolabile, tronchese, pinza becchi lunghissimi, pinza grip	519 M 150AX	5
Giraviti a taglio e croce PH	519 M 324H	8
Giraviti TORX® Tamper Resistant	519 M 324STX	7
Assortimento di punte HSS-G	988 MA/S19	19
Assortimento di inserti con cricchetto reversibile	692 J32	32

DESCRIZIONE	ART	PZ
Bussole esagonali, cricchetto (237 A 1/4"), accessori 1/4" ed inserti	519 M 613AEA	46
Bussole esagonali, cricchetto (237 A 1/2") e accessori 1/2"	519 M 613CEA	23
Chiavi combinate	519 M 285A1	17
Pinza universale, pinza regolabile, tronchese, pinza becchi lunghissimi, pinza grip	519 M 150AX	5
Giraviti a taglio e croce PH	519 M 324H	8
Giraviti TORX® Tamper Resistant	519 M 324STX	7
Assortimento di inserti RIBE con foro - XZN - TORX® Tamper Resistant	692 SP3	40
Chiavi a T snodate con bocca esagonale (10,13,17 mm)	276 CE	3

Vuoi solo l'assortimento? Vai a pagina 40



72 kg | mm | → 774
↓ 971
↙ 546

519 R6/3V

Cod. U05190414

6 CASSETTI

3 MODULI

Carrello RACING (vuoto) ●

519 R6/3NV

Cod. U05190424

6 CASSETTI

3 MODULI

Carrello RACING (vuoto) ●

• Dimensioni interne:

- 4 cassetti 570x420x60 mm
- 1 cassetto 570x420x130 mm
- 1 cassetto 570x420x270 mm

~~€ 980,00~~ € 689,00



83 kg | mm | → 964
↓ 971
↙ 546

519 R6/4V

Cod. U05190419

6 CASSETTI

4 MODULI

Carrello RACING (vuoto) ●

519 R6/4NV

Cod. U05190429

6 CASSETTI

4 MODULI

Carrello RACING (vuoto) ●

• Dimensioni interne:

- 4 cassetti 760x420x60 mm
- 1 cassetto 760x420x130 mm
- 1 cassetto 760x420x270 mm

~~€ 1.141,00~~ € 799,00



94 kg | mm | → 1154
↓ 1000
↙ 546

519 R6/5V

Cod. U05190420

6 CASSETTI

5 MODULI

Carrello RACING (vuoto) ●

• Dimensioni interne:

- 3 cassetti 950x420x60 mm
- 2 cassetti 950x420x130 mm
- 1 cassetto 950x420x200 mm

~~€ 1.471,00~~ € 1.029,00



74 kg | mm | → 774
↓ 971
↙ 546

519 R7/3V

Cod. U05190415

7 CASSETTI

3 MODULI

Carrello RACING (vuoto) ●

• Dimensioni interne:

- 5 cassetti 570x420x60 mm
- 1 cassetto 570x420x130 mm
- 1 cassetto 570x420x200 mm

~~€ 1.075,00~~ € 749,00



76 kg | mm | → 774
↓ 971
↙ 546

519 R8/3V

Cod. U05190416

8 CASSETTI

3 MODULI

Carrello RACING (vuoto) ●

• Dimensioni interne:

- 6 cassetti 570x420x60 mm
- 2 cassetti 570x420x130 mm

~~€ 1.169,00~~ € 819,00



94 kg | mm | → 1154
↓ 1000
↙ 546

513 B6V

Cod. U05130096

6 CASSETTI

3 MODULI

Carrello BOOSTER (vuoto) ●

• Dimensioni interne:

- 4 cassetti 570x420x60 mm
- 1 cassetto 570x420x130 mm
- 1 cassetto 570x420x270 mm

• Vano laterale: 380x400x720 mm

~~€ 1.470,00~~ € 1.029,00



RISPARMI
€ 230

Rispetto all'acquisto di carrello ed assortimento separati

519 R6/3I-S

Cod. U05198022



157
PEZZI

Carrello RACING con assortimento MANUTENZIONE - 3 cassetti

~~€ 2.195,68~~ **€ 1.119,00**



RISPARMI
€ 230

Rispetto all'acquisto di carrello ed assortimento separati

519 R6/3A-S

Cod. U05198023



149
PEZZI

Carrello RACING con assortimento AUTORIPARAZIONE - 3 cassetti

~~€ 2.253,78~~ **€ 1.059,00**

ASSORTIMENTO MANUTENZIONE



ASSORTIMENTO AUTORIPARAZIONE

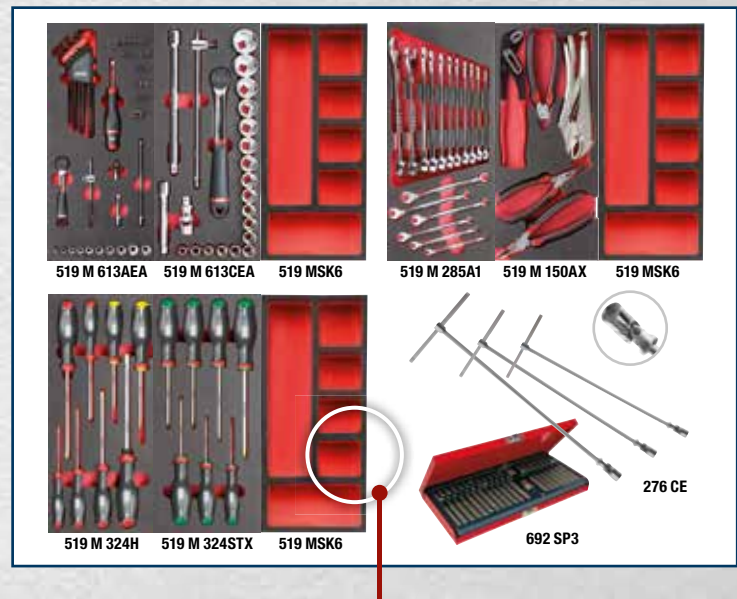

MODULI IN SPUGNA BICOLORE

DESCRIZIONE	ART	PZ
Bussole esagonali, cricchetto (237 A 1/4"), accessori 1/4" ed inserti	519 M 613AEA	46
Bussole esagonali, cricchetto (237 A 1/2") e accessori 1/2"	519 M 613CEA	23
Chiavi combinate	519 M 285A1	17
Pinza universale, pinza regolabile, tronchese, pinza becchi lunghissimi, pinza grip	519 M 150AX	5
Giraviti a taglio e croce PH	519 M 324H	8
Giraviti TORX® Tamper Resistant	519 M 324STX	7
Assortimento di punte HSS-G	988 MA/S19	19
Assortimento di inserti con cricchetto reversibile	692 J32	32

DESCRIZIONE	ART	PZ
Bussole esagonali, cricchetto (237 A 1/4"), accessori 1/4" ed inserti	519 M 613AEA	46
Bussole esagonali, cricchetto (237 A 1/2") e accessori 1/2"	519 M 613CEA	23
Chiavi combinate	519 M 285A1	17
Pinza universale, pinza regolabile, tronchese, pinza becchi lunghissimi, pinza grip	519 M 150AX	5
Giraviti a taglio e croce PH	519 M 324H	8
Giraviti TORX® Tamper Resistant	519 M 324STX	7
Assortimento di inserti RIBE con foro - XZN - TORX® Tamper Resistant	692 SP3	40
Chiavi a T snodate con bocca esagonale (10,13,17 mm)	276 CE	3

Vuoi solo l'assortimento? Vai a pagina 40

Carrelli portautensili



18 kg
mm
750
950
450

504 S

Cod. U05040003

Carrello multiuso

- Ripiani protetti con materiale plastico ad alta resistenza
- Maniglia in acciaio per una maggiore manovrabilità
- Due ruote pivotanti (Ø 100 mm) e due ruote fisse (Ø 100 mm)
- Fornito smontato

~~€ 164,00~~

€ 119,00

3
RIPIANI



128 kg
mm
1.212
912
670

514 B6V

Cod. U05140001

Banco da lavoro mobile BULL (vuoto)

- Piano di lavoro in legno multistrato
- Portata massima cassette: 20 kg
- Vano laterale: 380x704x524 mm
- Dimensioni interne:
 - 3 cassette 570x420x60 mm
 - 2 cassette 570x420x130 mm
 - 1 cassetto 570x420x270 mm

~~€ 1.869,00~~

€ 1.309,00

6
CASSETTI

3
MODULI

ACCESSORI CARRELLI



519 RA1

Cod. U05190207

Portarifiuti

per Racing, Sprint, Start, Booster e Bull

~~€ 87,00~~

€ 61,00



519 RA2

Cod. U05190208

Portadocumenti

per Racing, Sprint, Start, Booster e Bull

~~€ 48,30~~

€ 33,80



519 RA3

Cod. U05190209

Pannello superiore

per Racing (3 moduli)

~~€ 138,00~~

€ 96,60



519 RA4

Cod. U05190210

Portarotolo

per Racing, Sprint, Start, Booster e Bull

~~€ 51,00~~

€ 35,70



519 RA5

Cod. U05190211

Portaflaconi

per Racing, Sprint, Start, Booster e Bull

~~€ 76,50~~

€ 53,60



519 RA6

Cod. U05190217

Piano appoggio pieghevole

per Racing

~~€ 138,00~~

€ 96,60



519 RA8

Cod. U05190219

Supporto per documenti

per Racing

~~€ 55,00~~

€ 38,50



519 RA9

Cod. U05190218

Piano in legno per morsa

per Racing

~~€ 138,00~~

€ 96,60

31 kg | mm | 720
810
280

NEW



**MANIGLIA
IN ALLUMINIO**

502 R1V

Cod. U05020001

1
CASSETTO

Armadio vuoto - 1 cassetto

- Pannelli forati interni
- Apertura a 180° delle ante
- Cassetto ad estrazione totale
- Guide telescopiche a sfera
- Maniglia cassetto in alluminio anodizzato
- Chiusura a serratura centralizzata
- Possibilità di ancoraggio a parete o posizionamento su carrelli Racing 519R a 3 moduli (con kit tubi di montaggio U050100193)
- Ante verniciate colore rosso RAL 3020
- Ganci e supporti non inclusi
- Dimensioni interne cassetto: 569x210x60 mm

~~€ 750,00~~

€ 525,00

45 kg | mm | 720
1.000
280

NEW



**MANIGLIE
IN ALLUMINIO**



**Ante con doppio
pannello**

502 R2V

Cod. U05020003

2
CASSETTI

Armadio vuoto - 2 cassetti

~~€ 930,00~~

€ 651,00



NEW

25 kg | mm | 1455
810
280

654 RV

Cod. U06540001

Armadio a tapparella scorrevoile

- Pannelli forati interni
- Tapparella in plastica a scorrimento orizzontale
- Maniglia tapparella in metallo
- Struttura in lamiera d'acciaio verniciata RAL 3020
- Possibilità di ancoraggio a parete
- Ganci e supporti non inclusi

~~€ 810,00~~

€ 567,00

ACCIAIO



506 A2

Banco da lavoro con piano in acciaio

- Piano in lamiera d'acciaio zincata (spessore 2,5) con bordi anticaduta altezza 37 mm
- Ripiano inferiore d'appoggio incluso
- Predisposizione per il fissaggio al pavimento
- Struttura in lamiera d'acciaio verniciata, colore nero RAL 9004
- 4 montanti per le lunghezze 1 m e 1,5 m
- 6 montanti per la lunghezza 2 m
- Possibilità di montare il cassetto 506 U130

CODICE	L (mm)	P (mm)	H (mm)			
U05060011	1.000	700	850	50 kg	€ 235,00	€ 165,00
U05060012	1.500	700	850	63 kg	€ 333,00	€ 233,00
U05060013	2.000	700	850	85 kg	€ 416,00	€ 291,00

501 P

Pannelli forati

- Diametro fori 5 mm
- Lamiera di acciaio, spessore 1,2 mm
- Esecuzione verniciata colore rosso RAL 3020
- Utilizzabile con ganci serie 552÷559 e 5003 SG

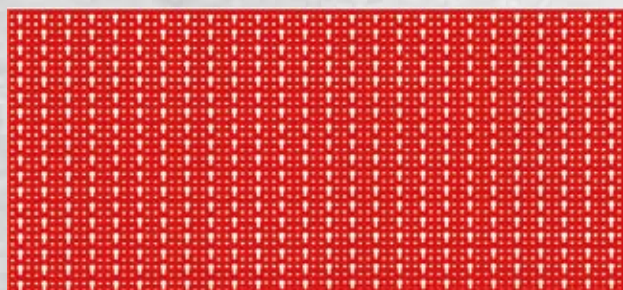

CODICE	DIMENSIONI	PESO		
U05010103Q	1000x800 mm	9,5 kg	€ 89,50	€ 62,50
U05010104Q	1500x800 mm	13,5 kg	€ 150,00	€ 105,00
U05010105Q	2000x800 mm	17,5 kg	€ 172,00	€ 120,00

498 B

Morse parallele da banco

- Modello in acciaio interamente forgiato con ganasce e corpo in un solo pezzo
- Ganasce posteriori con piano ad incudine
- Doppia guida prismatica rettificata con viti per la regolazione del parallelismo delle ganasce ed il recupero dei giochi
- Fornite con ganasce stringitubo

CODICE	AXBXC	L	PESO		
U04980012	100x125x74 mm	345 mm	6,9 kg	€ 216,00	€ 151,00
U04980013	125x150x83 mm	380 mm	10,7 kg	€ 257,00	€ 180,00
U04980014	150x200x94 mm	460 mm	18 kg	€ 348,00	€ 244,00
U04980015	175x235x123 mm	532 mm	25 kg	€ 459,00	€ 321,00

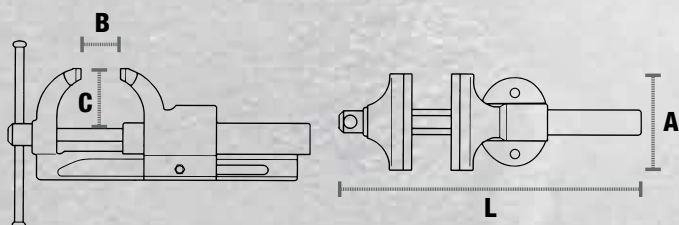

START 516



102 kg | mm | 2.000
850
700

516 SPC2

Cod. U05160021

6 CASSETTI | 3 MODULI

Banco da lavoro START con piano in acciaio

- Dimensioni interne cassetti:
 - 3 cassetti 570x420x60 mm
 - 2 cassetti 570x420x130 mm
 - 1 cassetto 570x420x200 mm

~~€ 1.121,00~~

€ 750,00



115 kg | mm | 2.000
850
700

516 SPC1

Cod. U05160020

6 CASSETTI | 3 MODULI

Banco da lavoro START con piano in legno

- Dimensioni interne cassetti:
 - 3 cassetti 570x420x60 mm
 - 2 cassetti 570x420x130 mm
 - 1 cassetto 570x420x200 mm

~~€ 1.121,00~~

€ 750,00

RACING 519

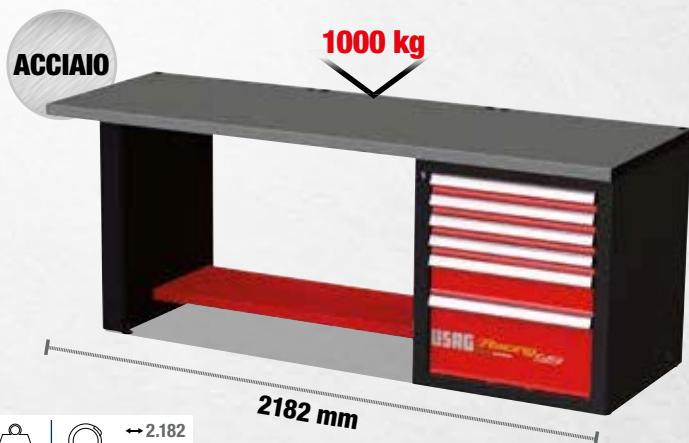

170 kg | mm | 2.182
850
750

519 RC2 H1

Cod. U05192004

6 CASSETTI | 3 MODULI

Banco da lavoro RACING con piano in acciaio

- Dimensioni interne cassetti:
 - 4 cassetti 570x420x60 mm
 - 1 cassetto 570x420x130 mm
 - 1 cassetto 570x420x270 mm

~~€ 1.900,00~~

€ 1.330,00

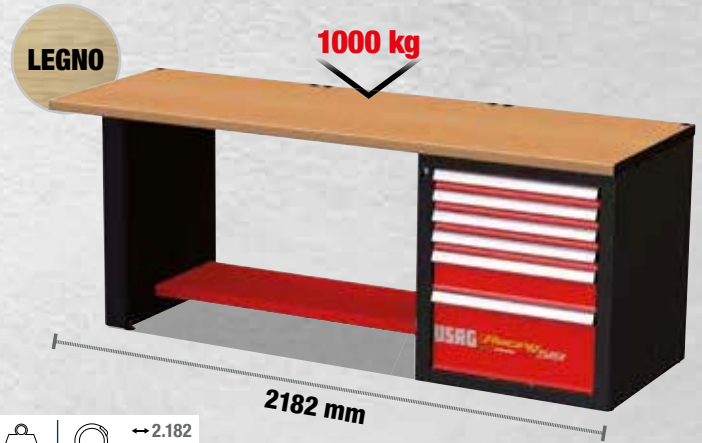

170 kg | mm | 2.182
850
750

519 RC1 H1

Cod. U05192003

6 CASSETTI | 3 MODULI

Banco da lavoro RACING con piano in legno

- Dimensioni interne cassetti:
 - 4 cassetti 570x420x60 mm
 - 1 cassetto 570x420x130 mm
 - 1 cassetto 570x420x270 mm

~~€ 1.897,00~~

€ 1.328,00

Prolunghe a catena



RAPPORTO DI TRASMISSIONE SISTEMA CORONA-PIGNONE

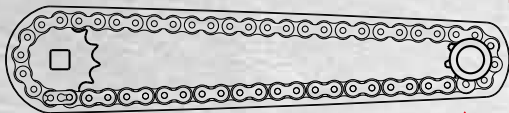

CORONA

per attacco utensile

PIGNONE

PIÙ GIRI IN USCITA

MASSIMA ACCESSIBILITÀ DIMENSIONI TESTA COME UN CRICCHETTO*



39 mm

*Confronto con cricchetto da 1/2"

UTILIZZO CON CRICCHETTO



VANTAGGI:

- 1** MAGGIOR SPAZIO DI MANOVRA
- 2** MOLTIPLICA I GIRI IN USCITA FINO A 1,6 VOLTE

UTILIZZO CON AVVITATORE



VANTAGGI:

- 1** PER INTERVENTI IN SPAZI RISTRETTI
- 2** AUMENTO FREQUENZA IMPULSI AL MINUTO FINO AL 20%

NEW



1/2"

1/4"

236 K

Prolunga a catena in alluminio

CODICE	☑	L	H	📏		
U02360700	1/2"	340 mm	39 mm	1,1 kg	€ 100,00	€ 69,00
U02360698	1/4"	260 mm	27 mm	300 g	€ 75,00	€ 49,00

NEW



1/2"

3 kg | 435 mm | 70 | 270

236 K/C13

Cod. U02360852



13
PEZZI

Assortimento in cassetta modulare con bussole esagonali macchina

DESCRIZIONE	ART./MISURA	PZ.
Prolunga a catena	236 K 1/2"	1
Bussole esagonali macchina	235 1/2 M 10-11-12-13-14-15-16-17-18-19-22-24	12

~~€ 240,15~~

€ 168,00

NEW



1/2"

4 kg | 435 mm | 70 | 270



236 K/C20

Cod. U02360851



20
PEZZI

Assortimento in cassetta modulare con bussole esagonali, cricchetto ed accessori

DESCRIZIONE	ART./MISURA	PZ.
Prolunga a catena	236 K 1/2"	1
Bussole esagonali	235 1/2" EN 10-11-12-13-14-15-16-17-18-19-21-22-24-27-30-32	16
Snodo cardanico	241 1/2"	1
Cricchetto reversibile certificato IP51	237 A 1/2"	1
Prolunga	236 1/2"125	1

~~€ 292,02~~

€ 204,00

NEW



1/4"

1,5 kg | 330 mm | 60 | 215



236 K/C27

Cod. U02360850



27
PEZZI

Assortimento in cassetta modulare con bussole esagonali, cricchetto, accessori e inserti

DESCRIZIONE	ART./MISURA	PZ.
Prolunga a catena	236 K 1/4"	1
Bussole esagonali	235 1/4" EN 5,5-6-7-8-9-10-11-12-13-14	10
Cricchetto reversibile certificato IP51	237 A 1/4"	1
Bussola portainseri	684 1/4"	1
Prolunghe	236 1/4"50-100	2
Inserti a croce PHILLIPS®	660 PH 1-2-3	3
Inserti esagono maschio	660 E 3-4-5-6-7	5
Inserti TORX® Tamper Resistant	660 STX T15-T20-T25-T30	4

~~€ 209,41~~

€ 146,00



IL TOP DI GAMMA

**ILLUMINAZIONE
A LED
REMOVIBILE E
RICARICABILE**



**CARTER IN LEGA
DI MAGNESIO
ULTRALEGGERO E RESISTENTE**

943 PC1 1/2"

Cod. U09430001

Avvitatore ad impulsi in magnesio – Top di gamma

- Carter in lega di magnesio
- Alloggiamento corpo motore in alluminio
- Unità LED rimovibile e ricaricabile tramite USB (Batteria Li-Ion 3.7V 180 mAh)
- Modello reversibile con meccanismo a doppio martello
- 3 livelli di potenza impostabili per il serraggio, coppia sempre al massimo in svitatura
- Pulsante di controllo dell'aria progressivo
- Paracolpi laterali in gomma
- Peso bilanciato per il massimo comfort
- Impugnatura bimateriale soft-touch
- Silenziatore e scarico dell'aria integrati nell'impugnatura

CARATTERISTICHE TECNICHE

Attacco quadro	1/2"
Capacità bullone	M20
Coppia massima	1.898 Nm
Coppia di lavoro	320÷460 Nm
Impulsi al minuto	1200
Velocità a vuoto	6.500 giri/min
Consumo medio aria	172 l/min

CARATTERISTICHE TECNICHE

Pressione aria raccomandata	6,2 bar
Pressione sonora	94 ±3 dB(A)
Potenza sonora	105 ±3 dB(A)
Vibrazioni	6,4 m/s ²
Attacco aria	1/4"
Diametro interno tubo aria	10 mm
Peso	2,2 kg

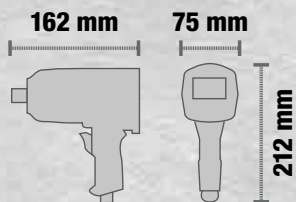

1.898 Nm

2,2 kg

~~€ 435,00~~

€ 299,00

IL COMPATTO

**ILLUMINAZIONE
A LED
REMOVIBILE E
RICARICABILE**



**CARTER IN LEGA
DI MAGNESIO
ULTRALEGGERO E RESISTENTE**

943 PC2 1/2"

Cod. U09430002

Avvitatore ad impulsi in magnesio con LED - extra compatto

- Carter in lega di magnesio: ultraleggero e resistente
- Alloggiamento corpo motore in alluminio
- Modello reversibile con meccanismo a doppio martello
- 3 livelli di potenza impostabili per il serraggio, coppia sempre al massimo in svitatura
- Inversione e regolazione con leva in alluminio
- Pulsante di controllo dell'aria progressivo
- Paracolpi laterali in gomma
- Peso bilanciato per il massimo comfort
- Impugnatura bimateriale soft-touch
- Silenziatore e scarico dell'aria integrati nell'impugnatura

CARATTERISTICHE TECNICHE

Attacco quadro	1/2"
Capacità bullone	M16
Coppia massima	950 Nm
Coppia di lavoro	200÷270 Nm
Impulsi al minuto	1400
Velocità a vuoto	10.000 giri/min
Consumo medio aria	167 l/min

CARATTERISTICHE TECNICHE

Pressione aria raccomandata	6,2 bar
Pressione sonora	95±3 dB(A)
Potenza sonora	107±3 dB(A)
Vibrazioni	3,9 m/s ²
Attacco aria	1/4"
Diametro interno tubo aria	10 mm
Peso	1,4 kg

NEW

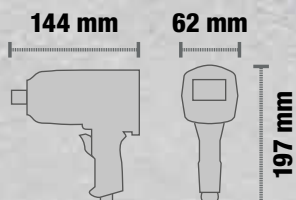

950 Nm

1,4 kg

~~€ 370,00~~

€ 259,00



IL MODELLO DI RIFERIMENTO



CARTER IN LEGA DI MAGNESIO ULTRALEGGERO E RESISTENTE

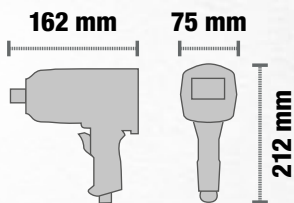

929 PC1 1/2"

Cod. U09290001



Avvitatore ad impulsi in magnesio

- Carter in lega di magnesio
- Alloggiamento corpo motore in alluminio
- Modello reversibile con meccanismo a doppio martello
- 3 livelli di potenza impostabili per il serraggio, coppia sempre al massimo in svitatura
- Pulsante di controllo dell'aria progressivo
- Paracolpi laterali in gomma
- Peso bilanciato per il massimo comfort
- Impugnatura bimatereale soft-touch
- Silenziatore e scarico dell'aria integrati nell'impugnatura

CARATTERISTICHE TECNICHE		CARATTERISTICHE TECNICHE	
Attacco quadro	1/2"	Pressione aria raccomandata	6,2 bar
Capacità bullone	M16	Pressione sonora	93 ±3 dB(A)
Coppia massima	1.600 Nm	Potenza sonora	104 ±3 dB(A)
Coppia di lavoro	280÷440 Nm	Vibrazioni	6,2 m/s ²
Impulsi al minuto	1.300	Attacco aria	1/4"
Velocità a vuoto	7.000 giri/min	Diametro interno tubo aria	10 mm
Consumo medio aria	172 l/min	Peso	2,0 kg

~~€ 335,00~~

€ 230,00

L'AVVITATORE IN ALLUMINIO



CORPO IN ALLUMINIO

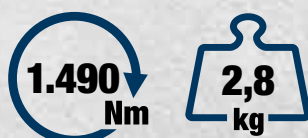
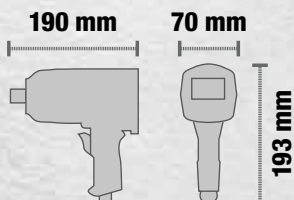

928 AC1 1/2"

Cod. U09280014



Avvitatore ad impulsi in alluminio

- Alloggiamento corpo motore in alluminio
- Carter in acciaio
- Modello reversibile con meccanismo a doppio martello
- Regolatore di potenza in 7 livelli, in entrambi i sensi di rotazione
- Pulsante di controllo dell'aria progressivo
- Impugnatura bimatereale soft-touch
- Silenziatore e scarico dell'aria integrati nell'impugnatura

CARATTERISTICHE TECNICHE		CARATTERISTICHE TECNICHE	
Attacco quadro	1/2"	Pressione aria raccomandata	6,2 bar
Capacità bullone	M16	Pressione sonora	90 ±3 dB(A)
Coppia massima	1.490 Nm	Potenza sonora	101 ±3 dB(A)
Coppia di lavoro	135÷380 Nm	Vibrazioni	5,2 m/s ²
Impulsi al minuto	1.120	Attacco aria	1/4"
Velocità a vuoto	6.500 giri/min	Diametro interno tubo aria	10 mm
Consumo medio aria	147 l/min	Peso	2,8 kg

~~€ 264,00~~

€ 181,00

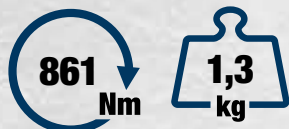
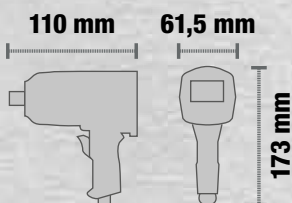

942 PC3 1/2"

Cod. U09420012



Avvitatore ad impulsi - extra compatto

- Struttura extra compatta: 11 cm di lunghezza
- Modello reversibile con sistema di percussione JUMBO
- Motore monoblocco
- Scarico dell'aria convogliato nell'impugnatura
- 3 livelli di potenza impostabili per il serraggio, coppia sempre al massimo in svitatura
- Corpo ed impugnatura in materiale antiscivolo
- Paracolpi laterali a protezione del carter motore
- Peso bilanciato per il massimo comfort anche per uso prolungato

CARATTERISTICHE TECNICHE

Attacco quadro	1/2"
Capacità bullone	M16
Coppia massima	861 Nm
Coppia di lavoro	150÷220 Nm
Impulsi al minuto	1650
Velocità a vuoto	10.000 giri/min
Consumo medio aria	127 l/min

CARATTERISTICHE TECNICHE

Pressione aria raccomandata	6,2 bar
Pressione sonora	91,1±3 dB(A)
Potenza sonora	108,1±3 dB(A)
Vibrazioni	9,57 m/s ²
Attacco aria	1/4"
Diametro interno tubo aria	10 mm
Peso	1,3 kg

~~€ 216,00~~

€ 159,00

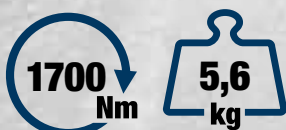
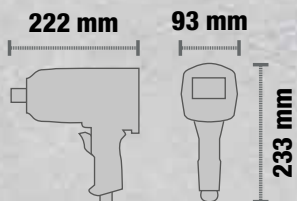

928 D1 3/4"

Cod. U09280015



Avvitatore ad impulsi in alluminio

- Modello reversibile con meccanismo a doppio martello
- 6 livelli di potenza impostabili in avvitamento e svitamento

CARATTERISTICHE TECNICHE

Attacco quadro	3/4"
Capacità bullone	M24
Coppia massima	1.700 Nm
Coppia di lavoro	500÷1.050 Nm
Impulsi al minuto	790
Velocità a vuoto	5.700 giri/min
Consumo medio aria	193 l/min

CARATTERISTICHE TECNICHE

Pressione aria raccomandata	6,2 bar
Pressione sonora	98,4±3 dB(A)
Potenza sonora	109,4±3 dB(A)
Vibrazioni	9,1 m/s ²
Attacco aria	3/8"
Diametro interno tubo aria	13 mm
Peso	5,6 kg

~~€ 815,00~~

€ 570,00

TORCIA A LED RICARICABILE

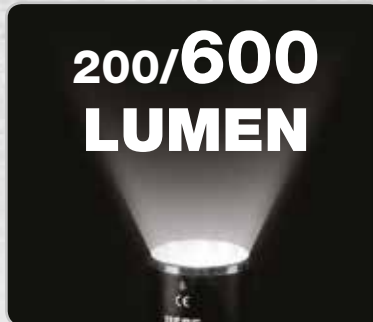

- SMD LED
- 2/5 h
- Li-ion
- IP54
- 6 h

889 TR

Cod. U08890073

Torcia LED in alluminio ricaricabile

~~€ 65,00~~

€ 45,50

MODELLI A BATTERIA STILO



889 TL

Cod. U08890072

Torcia a LED in alluminio

~~€ 50,00~~

€ 35,00

889 TM

Cod. U08890071

Torcia a LED stilo in alluminio

~~€ 30,00~~

€ 21,00

889 TS

Cod. U08890070

Torcia a LED stilo in alluminio

~~€ 25,00~~

€ 17,50

190-680 lm
Funzione STROBO

SMD LED 6-15 h

IP54 3 x C

55-170 lm
Funzione STROBO

SMD LED 1,5-3 h

IP54 2 x AA

50-110 lm
Funzione STROBO

SMD LED 1,5-3 h

IP54 2 x AAA

EXTRA SOTTILE ALTA LUMINOSITÀ



2 LIVELLI
DI LUMINOSITÀ



889 SA

Cod. U08890019

Lampada ispezione a LED
extra sottile ad alta luminosità

~~€ 114,00~~

€ 79,00



YouTube

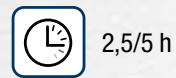

SOTTOCOFANO A LED



889 UB

Cod. U08890034

Lampada LED sottocofano ricaricabile

~~€ 175,00~~

€ 122,00



COLORATE NON LE PERDI PIÙ!



DOPPIA FUNZIONE

RICARICABILE



LAMPADA



TORCIA



889 RD

Cod. U08890035

Lampada di ispezione a LED

~~€ 96,50~~

€ 67,00



YouTube



SMD LED



Lampada: 5 h
Torcia: 9 h



IK07



IP20



4,5 h



Li-ion

DOPPIA FUNZIONE

RICARICABILE



LAMPADA



TORCIA



889 RP

Cod. U08890045

Lampada a LED ricaricabile compatta

~~€ 58,00~~

€ 40,00



YouTube



Lampada COB LED



Torcia SMD LED



Lampada: 3 h
Torcia: 10 h



IP20



4,5 h



Li-ion

207 E

FORBICE PER ELETTRICISTI



**L'UNICA CON STRUTTURA
INTEGRALE IN ACCIAIO INOX**
resiste alla flessione fino a 180 kg



SPELLAFILI INTEGRATO



1. Spellatura
2. Crimpatura

TAGLIACAVI SU ENTRAMBE LE LAME



Adatto per cavi multipolari

SUPPORTO PASSACINTURA



LAMA MICRODENTATA ANTISCIVOLO



YouTube

207 E

Cod. U02070006

Forbice professionale per elettricisti

~~€ 34,60~~

€ 24,00





0,02÷10 mm²



146 A

Cod. U01460003

Pinza spellafili automatica diritta

- Funzioni di taglio e spellatura dei fili elettrici
- Capacità 0,02-10 mm²/AWG 34-80
- Ganasce intercambiabili senza uso di utensili
- Tagliafilo integrato nel corpo dell'utensile

~~€ 89,00~~

€ 62,00

146 B

Cod. U01460004

Pinza spellafili automatica piegata a 90°

- Funzioni di taglio e spellatura dei fili elettrici
- Capacità 0,02-10 mm²/AWG 34-80
- Ganasce intercambiabili senza uso di utensili
- Tagliafilo integrato nel corpo dell'utensile

~~€ 103,00~~

€ 72,00

**BLOCCO DI
SICUREZZA LAMA**

**BLOCCO
GRILLETTO**
con lama estratta



PVC
Ø 4÷28 mm



163

Cod. U01630001

Sguainacavi multifunzione

- Per il taglio circolare e longitudinale di
- cavi con rivestimento esterno in PVC
- Sistema a grilletto (-30% di sforzo): forza necessaria 75 N
- Rotella di avanzamento della lama
- Lama di spellatura auto rotante
- Blocco grilletto con lama estratta
- Blocco di sicurezza della lama
- Corpo ergonomico in materiale plastico
- Lama di ricambio inclusa

~~€ 35,70~~

€ 25,00



YouTube

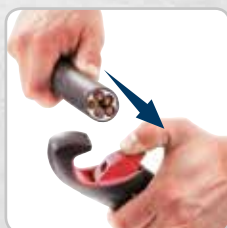

MODELLO COMPATTO

SMART FUNCTION

SELEZIONE AUTOMATICA DELLA TENSIONE AC/DC, RESISTENZA, FREQUENZA E CAPACITÀ



NEW

074 A

Cod. U00740001

MAX 600 V

RMS

Multimetro digitale compatto SMART

- Misurazione di AC/DC
- Misurazioni di resistenza e continuità (suono acustico se resistenza circuito è inferiore 40 a Ω)
- Misurazioni frequenza
- Misurazione corrente AC/DC con pinza amperometrica 076 P
- Tasto HOLD: blocca il valore visualizzato
- Tasto MAX/MIN: Per visualizzare il valore minimo e massimo tra i dati misurati
- Display digitale con retroilluminazione
- Spegnimento automatico dopo 15 minuti
- Indicatore stato di carico della batteria
- Fornito con coppia di puntali isolati e custodia

CARATTERISTICHE TECNICHE

Tensione continua DC (mV÷V)	1÷600
Tensione alternata AC (mV÷V)	1÷600
Resistenza (Ω ÷M Ω)	0÷10
Frequenza kHz	3÷40
Tipo batterie (fornite)	2xAAA 1,5V

230 g | 152 mm | 45 mm | 72 mm

CAT III 600V CE

~~€ 127,00~~

€ 89,00



076 A

Cod. U00760003

MAX 600 V

MAX 10 A

Multimetro Digitale Professionale

- Misura di tensione e corrente AC/DC, frequenza, resistenza e capacità
- Prova di continuità e diodi
- Funzione ciclo di lavoro
- Auto calibrazione
- Memorizzazione dati
- Modalità relativa
- Fornito con coppia di puntali

CARATTERISTICHE TECNICHE

Tensione continua DC (mV÷V)	400÷600
Tensione alternata AC (mV÷V)	4÷600
Corrente continua DC (μ A÷A)	400÷10
Corrente alternata AC (μ A÷A)	400÷10
Resistenza (Ω ÷M Ω)	400÷40

CARATTERISTICHE TECNICHE

Capacità (nF÷ μ F)	40÷100
Frequenza kHz	10÷100
Risposta di frequenza Hz	40÷400
Protezione per sovraccarico DC/AC (V)	600
Tipo batterie (fornite)	1x9V 6F22

CAT III 600V

CE

~~€ 153,00~~

€ 109,00



Inserto in acciaio filettato per uno scorrimento rapido



RAME

314 C

Cod. U03140032

Ø
3-30
mm

Ø
1/8-1 1/8
"

Tagliatubi per tubi in rame e lega leggera

- Rulli di scorrimento scanalati per il taglio di tubi bordati
- Sostituzione rapida della rotella senza bisogno di utensili
- Spessore massimo tubo: 2 mm

~~€ 31,10~~

€ 21,50



Ritorno della lama con una sola mano.

PLASTICA

317 BM

Cod. U03170010

Ø
42
mm

Ø
1 5/8
"

Tagliatubi per tubi e profilati in plastica

- Per tubi in PVC, multistrato e PEX
- Azione di taglio progressiva con il minimo sforzo
- Sostituzione rapida della lama senza bisogno di utensili
- Lama completamente integrata nel corpo del prodotto
- Lama in acciaio Inox con geometria speciale e rivestimento in PTFE
- Ritorno della lama con una sola mano
- Impugnatura ergonomica bimatériale
- Dimensioni: 242x107x25 mm

~~€ 76,00~~

€ 53,00

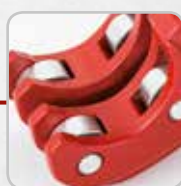

PLASTICA

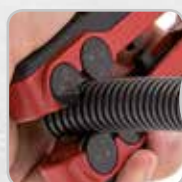

317 EM

Cod. U03170005

Ø
26
mm

Ø
1
"

Tagliatubi per tubi in PEX

- Lama con geometria speciale e rivestimento in PTFE
- 4 rulli con cuscinetti integrati nella ganascia per facilitare la rotazione del tubo durante il taglio
- Sistema a 4 lame integrato nell'impugnatura per il taglio delle canaline in tubo corrugato (diametro 18-35 mm) senza danneggiare il tubo interno
- Ritorno automatico della lama
- Sistema di chiusura con una sola mano
- Impugnatura ergonomica bimatériale
- Dimensioni: 189x65,5x28 mm

~~€ 88,00~~

€ 61,60

TAGLIO CANALINE

Sistema integrato nell'impugnatura per il taglio delle canaline in tubo corrugato (impianti sanitari)



DIN 1041



MATERIALI COMBINATI PER UN RISULTATO OTTIMALE.

1. Anima in grafite: massima resistenza alla flessione.
2. Elevata qualità: corpo in polipropilene che assorbe le vibrazioni.
3. Rivestimento in gomma resistente agli idrocarburi.

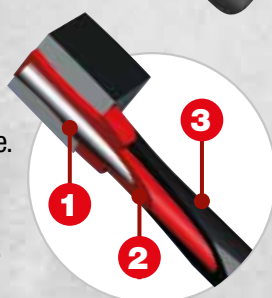

372 SE6

Cod. U03720181

Assortimento in busta di plastica

- 362/125-150 - Scalpelli
- 364/125 - Ugnetto
- 366/3x125-4x150 - Punzoni
- 368/4x125 - Bulino

6
PEZZI

~~€ 48,45~~

€ 32,00

367 SE6

Cod. U03670081

Serie di 6 cacciaspine

- 367/2x110-3x130-4x145-5x165-6x180-8x200 mm
- Fornita in busta di plastica
- Acciaio al Cromo Vanadio
- Punta riportate e fosfatate per le misure da 2 e 3 mm

6
PEZZI

~~€ 48,18~~

€ 33,50

376 F

Mazzuole con manico in grafite

- Modello a tasselli intercambiabili in acetato di cellulosa
- Corpo in acciaio al carbonio
- Manico in grafite

CODICE	Ø TASSELLI	LUNGHEZZA		
U03760012	25 mm	280 mm	€ 17,90	€ 12,50
U03760013	32 mm	304 mm	€ 22,80	€ 16,00
U03760014	40 mm	330 mm	€ 31,10	€ 21,80
U03760015	50 mm	362 mm	€ 42,60	€ 30,00

382 F

Martelli per meccanici manico in grafite

- Modello tedesco a testa quadra piana e penna simmetrica
- Manico in grafite

CODICE	PESO TESTA	LUNGHEZZA		
U03820102	200 g	285 mm	€ 16,50	€ 11,50
U03820103	300 g	300 mm	€ 17,60	€ 12,30
U03820105	500 g	310 mm	€ 20,00	€ 14,00
U03820107	800 g	350 mm	€ 24,70	€ 17,30
U03820108	1000 g	355 mm	€ 26,80	€ 18,70



YouTube



200 F

Cod. U02006003

Seghetto in alluminio con Tension Control

- Modello per lame da 300 mm
- Lama orientabile con 8 posizioni differenti, ogni 45° di rotazione
- Sistema di tensionamento della lama integrato nell'impugnatura e tarato a 110 Kg per un taglio ottimale
- Capacità di taglio costante (100 mm)
- Vibrazioni ridotte
- Corpo in Alluminio con impugnatura bimatereale
- Fornito con lama al Cobalto mod. 200 C24

~~€ 44,30~~

€ 31,00

SISTEMA DI TENSIONAMENTO DELLA LAMA

tarato fino a 110 kg per un taglio ottimale

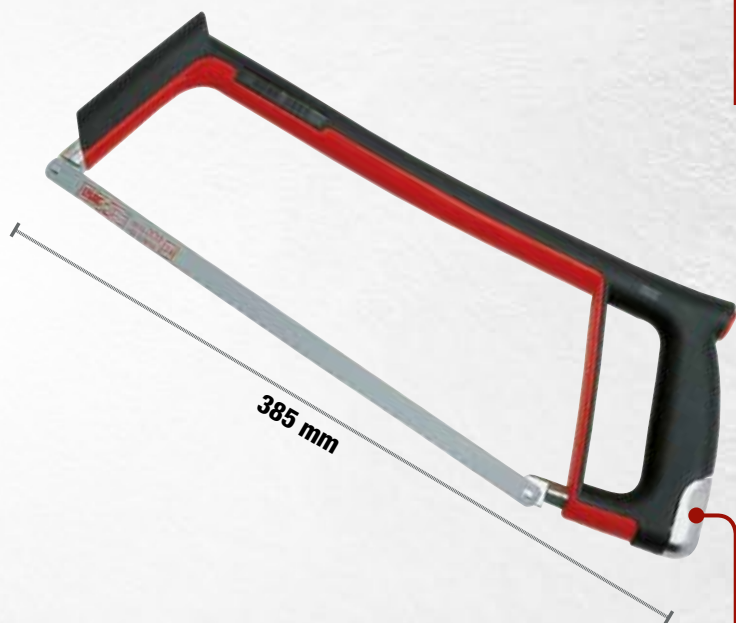

200 S

Cod. U02000002

Seghetto

- Modello per lame da 300 mm con possibilità di orientamento della lama a 45° ed a 90°
- Sistema di tensionamento della lama integrato nell'impugnatura
- Anima in acciaio rivestita in materiale plastico antiscivolo ed antiurto
- Fornito con lama in acciaio HSS BI-METAL 200 A/24

~~€ 30,40~~

€ 21,00

SISTEMA DI TENSIONAMENTO DELLA LAMA



200

Cod. U02000001

Seghetto

- Modello per lame da 300 mm con lama orientabile
- Vite per la regolazione della tensione della lama
- Impugnatura in alluminio
- Fornito con lama in acciaio

~~€ 16,00~~

€ 11,00

451 N/S4

Cod. U04510100

4
PEZZI

Estrattore a tre bracci per esterni

- Modello a bracci autoserranti
- Capacità: 7÷140 mm
- Potenza: 3 ton
- Spina di sicurezza
- Vite di manovra con esagono da 18 mm
- Possibilità di utilizzo a due bracci
- Viti di manovra M16x2

COMPRESSE
NEL PREZZO



~~€ 210,00~~

€ 147,00

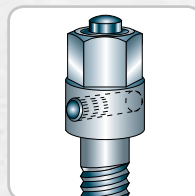

Spina di sicurezza: utilizzo sicuro e qualità dell'attrezzo preservata

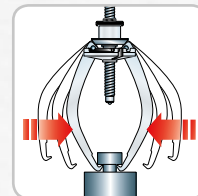

Autoserrante
Autocentrante



454 SE3

Cod. U04549002P

3
PEZZI

Serie di 3 estrattori a due bracci per esterni

- 454/0-1-2

~~€ 234,50~~

€ 162,00

458 S8

Cod. U04580013

8
PEZZI

Serie di 8 estrattori conici

- 458/1-2-3-4-5-6-7-8
- Fornita in astuccio di plastica

~~€ 49,30~~

€ 34,50



SCARPE ANTINFORTUNISTICHE S1P TOMAIA ALTAMENTE TRASPIRANTE

SOLETTA AMMORTIZZANTE

Confortevole, anatomica, antibatterica

Made in Italy

S1P
SRC
ESD



TOMAIA IN MESH
CON MICROFIBRA

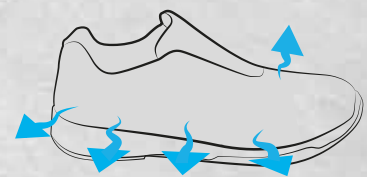

TRASPIRANTE

CALZATA



12

PUNTALE
IN COMPOSITO

SUOLA IN POLIURETANO BIDENSITÀ

iniettata direttamente sulla tomaia per la massima qualità

INTERSUOLA
ANTIPERFORAZIONE

100%
METAL
FREE

3500 S1P

Scarpe antinfortunistiche con tomaia traspirante

- Categoria S1P
- Calzatura bassa in Mesh con microfibra sovrastampata
- Fodera 100% poliestere con lavorazione a nido d'ape per migliorare il ricircolo dell'aria a vantaggio della traspirazione
- Puntale in composito leggero e resistente
- Soletta estraibile preformata, in poliuretano bicolore e bi-densità, traspirante, lavabile ed antibatterica. Offre ottime performance in termini di comfort e di ammortizzamento
- Suola in poliuretano bi-densità resistente alle flessioni ed alle abrasioni, antiolio, antiscivolo
- Intersuola confortevole antiperforazione
- Calzata 12
- 100% metal free
- Campi di impiego suggeriti: Lavori leggeri, industria meccanica, logistica/imballaggio

CE EN ISO 20345: 2011

TAGLIA	CODICE	TAGLIA	CODICE
36	U35000036	42	U35000042
37	U35000037	43	U35000043
38	U35000038	44	U35000044
39	U35000039	45	U35000045
40	U35000040	46	U35000046
41	U35000041	47	U35000047

~~€ 102,00~~

€ 59,00

443 N

CHIAVE AUTOMATICA PER FILTRI OLIO



YouTube



1
**ARMARE
E POSIZIONARE**



2
**ATTIVARE SERRAGGIO
AUTOMATICO**



3
**RIPRESA RAPIDA,
ECONOMIA DI TEMPO**



**LEVA DI INCREMENTO
POTENZA SERRAGGIO**

EFFETTO CRICCHETTO

- Rapidità e facilità d'uso anche in spazi ridotti

SERRAGGIO AUTOMATICO DEL NASTRO

- Velocizzazione dell'operazione
- Ottimizzazione dell'effetto cricchetto



443 N **66÷105 mm**

Cod. U04430005



**Chiave automatica a ripresa rapida
per filtri olio (autovetture)**

~~€ 90,00~~

€ 63,00

443 NC **106÷150 mm**

Cod. U04430007



**Chiave automatica a ripresa rapida
per filtri olio (veicoli industriali)**

~~€ 104,00~~

€ 73,00



263 RA

Cod. U02631600

80
Litri

Recuperatore olio

- Modello a caduta
- Indicatore laterale per la verifica del livello olio nel serbatoio
- Griglia in materiale plastico all'interno della coppa
- Sistema di svuotamento del serbatoio con aria compressa (max 3,5 bar)
- Tubo di scarico flessibile lungo 1800 mm
- 4 ruote pivotanti: \varnothing 70 mm

~~€ 526,00~~

€ 289,00



Compatibile con liquido freni DOT ed antigelo



Tubo esterno antiurto in poliuretano per il controllo del serbatoio



Blocco di giunzione in metallo con guarnizione interna in EPDM

263/S16

Cod. U02631400

16
PEZZI

Kit per tappi olio

- 1 chiave snodata con coppetta
- 2 inserti \varnothing 8-10 mm
- 6 inserti \varnothing 8-10-12-13-14-17 mm
- 6 bussole \blacklozenge 13-14-17-18-19-21 mm
- 1 inserto \odot T45



~~€ 162,00~~

€ 114,00

446 S28

Cod. U04461204

30
PEZZI

Assortimento di 30 chiavi per filtri olio

- Serie composta da 28 chiavi a tazza con quadro di manovra da 3/8", 1 adattatore da 3/8" a 1/2", 1 chiave autoserrante (capacità 65÷120 mm) con quadro di manovra da 3/8"
- Il set è adatto per la maggior parte dei filtri olio montati sui veicoli circolanti
- Misure delle 28 chiavi a tazza \varnothing x N°lati:
66/6 - 65/14 - 65/67 - 68/14 - 73/14 - 74/15 - 74/76 - 75/77 - 76/12 - 76/14 - 76/30 - 76/8 - 78/15 - 80/15 - 80/82 - 86/16 - 86/18 - 90/15 - 92/10 - 93/15 - 93/36 - 93/45 - 95/15 - 96/18 - 100/15 - 106/15 - 108/15 - 108/18

~~€ 174,00~~

€ 122,00

3/8"



3/8"

1/2"





871 AN

Cod. U08710005

Ø
18÷54
mm

Pinza per anelli stringitubo

- Per tubi di raffreddamento, riscaldamento e carburazione
- Braccio orientabile (600mm) che mantiene la posizione impostata
- Sistema a cremagliera per ridurre gli sforzi

~~€ 140,00~~

€ 98,00

2 in 1

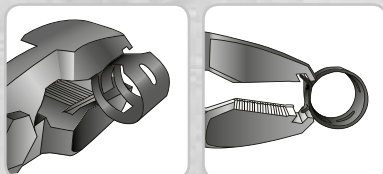

871 D

Cod. U08710001

Max
20
mm

Pinza per anelli stringitubo a presa frontale/laterale

- Possibilità di aggancio frontale o laterale
- Ganasce con superficie di presa zigrinata
- Molla interna di richiamo
- Impugnature ergonomiche antiscivolo

~~€ 46,80~~

€ 32,70



870 C

Cod. U08700006

Pinza per raccordi rapidi carburante

- Per veicoli a benzina e diesel
- Impugnature ergonomiche bimalteriali
- Lunghezza: 175 mm

~~€ 56,50~~

€ 39,60

3 POSIZIONI
DI LAVORO



871 C

Cod. U08719005P

Pinza per fascette automatiche CLIC

- Testa triassiale per lavorare in tutte le posizioni
- Permette di aprire o chiudere le fascette automatiche presenti sui circuiti del carburante, dei collettori d'aspirazione e dei circuiti idraulici

~~€ 66,50~~

€ 46,60



1 2"

800 g | mm | 210 | 60 | 130

270 B/C3

Cod. U02700105

Serie di 3 bussole per cerchi in lega con protezione in teflon

- 270 B/17-19-21 mm
- Fornita in cassetta di plastica

3
PEZZI

~~€ 96,50~~

€ 51,00

17 19 21



120°



L'inclinazione a 120° del becco garantisce la massima visibilità

115 CP

Cod. U01150024

Pinza piegata a becchi semitondi lunghissimi

- Corpo piegato rispetto all'asse dell'impugnatura per una presa frontale più comoda.
- Maggiore visibilità sul punto in cui si interviene.
- Superficie di presa zigrinata: lunghezza 32 mm.
- Ganasce sagomate anche per la presa sul tondo.
- Tagliente per filo duro integrato.
- Cerniera chiusa con molla di richiamo interna.
- Impugnature ergonomiche rivestite in materiale antiscivolo.

~~€ 32,70~~

€ 22,90

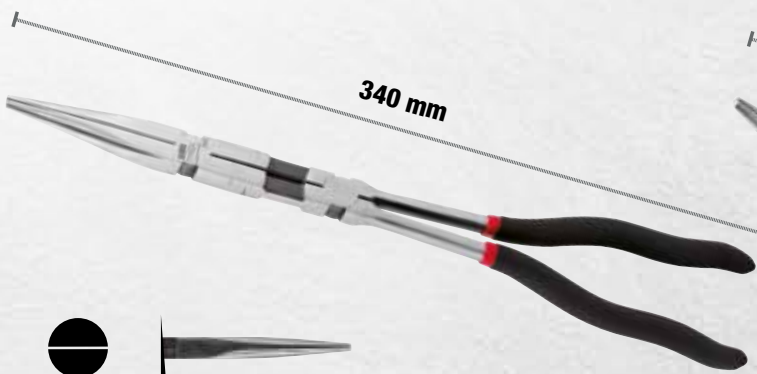

340 mm



115 CL

Cod. U01150020

Pinza doppio snodo a becchi mezzotondi dritti

~~€ 34,30~~

€ 24,00

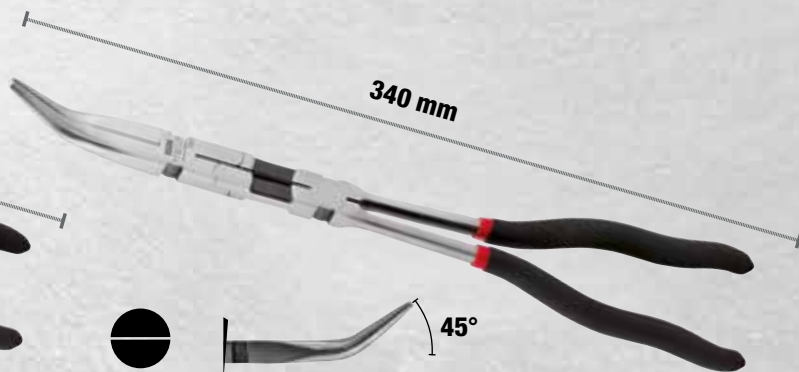

340 mm



45°

115 CLP

Cod. U01150021

Pinza doppio snodo a becchi mezzotondi piegati a 45°

~~€ 34,30~~

€ 24,00



CE

3t

2550 A

Cod. U25500001

3
TON

30,5
kg

Sollevatore idraulico 3T per auto e veicoli commerciali

- Struttura in acciaio
- Polivalente e compatto
- Portata elevata per utilizzo su auto, fuoristrada e furgoni
- Sistema a doppia pompa per sollevare più velocemente la vettura
- Dotato di comando di discesa manuale
- Valvola di spurgo dell'aria, per evitare il pericolo di over-carico
- Impugnatura con gomma antiurto
- Ruote in poliuretano

~~€ 294,00~~

€ 199,00



COMPATTO

615 mm di lunghezza



133÷465
mm

Pedale di avvicinamento

2t

CE

2550 B

Cod. U25500002

2
TON

32,5
kg

Sollevatore idraulico 2T

- Struttura in acciaio
- Per utilizzo in spazi ridotti
- Sistema a doppia pompa per sollevare più velocemente la vettura
- Dotato di pedale di avvicinamento
- Dotato di comando di discesa manuale
- Valvola di spurgo dell'aria, per evitare il pericolo di over-carico
- Impugnatura con gomma antiurto
- Ruote in poliuretano

~~€ 415,00~~

€ 295,00



Sottile

75 mm di altezza



75÷505
mm



1950 C

Coppia colonnette

- Altezza regolabile tramite meccanismo dentato con rilascio a leva
- Perno di bloccaggio con catena
- 1950 C/3: modello regolabile a 10 posizioni
- 1950 C/6: modello regolabile a 13 posizioni

CODICE	PORTATA	PESO		
U19501001	3 t	7 kg	€ 81,50	€ 57,00
U19501002	6 t	14 kg	€ 118,00	€ 82,50



447 T

Cod. U04470101

Smonta ammortizzatori pneumatico

- Ideale per autovetture
- Sistema di autolivellamento dei bracci superiori: adatto anche a molle coniche e disassate
- Boccole autolubrificanti: nessuna operazione di lubrificazione e/o ingrassaggio sulle colonne di scorrimento
- Fornito con due staffe inferiori 447 TC1 (78÷130 mm) e 447 TC2 (105÷182 mm), morsa 447 TA e morsetti superiori universali 447 TB1

CARATTERISTICHE TECNICHE

Potenza compressione	735 kg (6 bar) - 1226 kg (10 bar)
Pressione di esercizio	6÷10 bar
Corsa del pistone	420 mm
Cilindro	Doppio in lega d'alluminio e resina al nylon

~~€ 1.688,00~~

€ 1.170,00



POTENZA DI COMPRESSIONE

735 kg (6 bar)
1226 kg (10 bar)



YouTube



CONFORMITA' ALLA DIRETTIVA MACCHINE

Gli smontammortizzatori pneumatici USAG sono progettati per rispondere pienamente alla Direttiva Macchine 2006/42/CE. Alcune funzionalità della macchina sono state impostate perché l'operatore possa lavorare in totale sicurezza:

- Protezione frontale di sicurezza
- Dispositivo di arresto del pistone in caso di apertura della protezione frontale
- Velocità limitata: sempre inferiore ai 10 cm/sec
- Sistema di blocco delle ganasce e del pistone in caso di interruzione dell'alimentazione dell'aria



150 kg

2000 A

Cod. U20000100

Lettino sottoscocca 6 ruote

- Cuscino poggiatesta in vinile resistente agli idrocarburi.
- Struttura in materiale plastico resistente agli idrocarburi, lavabile
- Due vaschette porta utensili laterali
- Altezza massima da terra: 115mm
- Fornito con 6 ruote in gomma pivottanti Ø 80mm (da montare)

~~€ 106,00~~

€ 72,00



3500 A



BATTERIE AGM
(Absorbed Glass Mat)



1613 AB12

Cod. U16130009

12 V - **1200 A**

Avviatore portatile 12V

- Per avviamento di soccorso, come caricabatterie e come fonte di energia supplementare per veicoli (salvamemorie) e per apparecchi elettrici 12V
- Scocca antiurto in ABS
- Protezione da sovratensione
- Idoneo anche per batterie sigillate
- Pinze inclinate
- Fornito con caricatore di rete e cavo per presa accendisigari

~~€ 487,00~~

€ 340,00

LUNGHEZZA CAVI 155 cm



BATTERIE AGM
(Absorbed Glass Mat)



12 V

4600 A

24 V

2300 A



1613 AB12-24

Cod. U16130011

12 V
24 V

Avviatore portatile 12-24V

- Avviatore portatile d'emergenza per la messa in moto di veicoli con batterie funzionanti ma scariche, con possibilità di erogare tensioni a scelta da 12 o 24V
- Indicato per l'utilizzo su ogni tipo di mezzo: auto, mezzi commerciali, camion, macchine movimento terra, trattori agricoli, imbarcazioni, ecc.
- Voltmetro digitale con doppia funzionalità: indicazione dello stato di carica della batteria interna (in volts e in %) e indicazione del voltaggio della batteria del veicolo
- Scocca antiurto in ABS
- Protezione da sovratensione
- Idoneo per batterie sigillate
- Pinze inclinate
- Fornito con cavo di rete e cavo per presa accendisigari

~~€ 1.018,00~~

€ 712,00

LUNGHEZZA CAVI 146 cm



1881 S22

Cod. U18810082

22
PEZZI

Kit universale per lo smontaggio e il montaggio delle ghiera pulegge alternatori

- Fornito in cassetta di plastica

~~€ 119,00~~

€ 83,00



SPURGATORE PER CIRCUITO FRENI

PRESSIONE REGOLABILE FINO A 4 BAR



2847/3

Cod. U28470084

Spurgatore per circuito freni

- Permette di cambiare, riempire, spurgare i circuiti dei freni di autovetture e veicoli industriali
- Apparecchio progettato esclusivamente per liquidi freno tipo DOT 3, DOT 4, DOT 5.1. No LHM
- Pressione regolabile fino a 4 bar
- Arresto automatico al 10% del serbatoio (1 L)
- Alimentazione 12 V tramite cavi batteria
- Vano posteriore accessori
- Ruote integrate e maniglione per un facile trasporto

CARATTERISTICHE TECNICHE

Sistema di manovra del liquido	Pompa peristaltica (nessun contatto diretto pompa liquido, nessuna pressione aria sul liquido)
Alimentazione	12 V (morsetti batteria)
Capacità serbatoio	10 litri
Limitatore di pressione	4 bar
Tubo a spirale	4 m (elastico)
Cavo di alimentazione	4 m

~~€ 1.333,00~~

€ 933,00



Fornito con:

- guarnizioni di ricambio,
- 1 tappo multidiametro 44-45-46 mm (2847 N11)
- 1 contenitore di recupero olio



Magnete
capacità: 1,5 Kg
4 artigli flessibili con LED
capacità: 2 Kg



IP 54

L530 mm

046 L

Cod. U00460001

POWER
LED

7
LUMEN

Artiglio prensile con LED

- Pinzetta retrattile a 4 griffe con LED integrato azionabile tramite pulsante
- Magnete all'estremità per recuperare piccole parti in metallo
- Asta flessibile in acciaio cromato

CARATTERISTICHE TECNICHE

Tipo e numero LED	1 Power LED
Luminosità	7 Lumen / 100 Lux
Tipo batteria	3 x LR44 (Fornite)
Autonomia	8 ore
Categoria protezione	IP 54
Temperatura di utilizzo	-20°C ÷ + 50°C



~~€ 40,10~~

€ 28,00

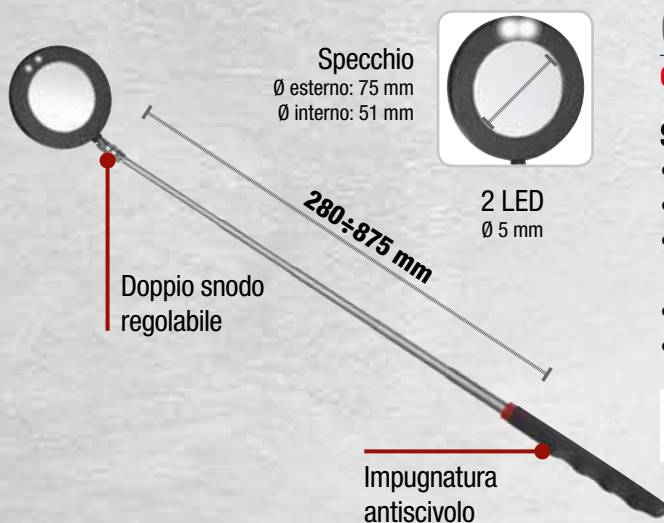

Specchio
Ø esterno: 75 mm
Ø interno: 51 mm



2 LED
Ø 5 mm

280÷875 mm

Doppio snodo
regolabile

Impugnatura
antiscivolo

056 L

Cod. U00560001

2
LED

5
LUMEN

Specchietto telescopico snodato a LED

- Specchio in vetro resistente alle rigature
- Bordo paraurti in materiale plastico
- 2 LED per evitare di creare ombre sulla zona da osservare
- Doppio snodo regolabile
- Corpo in acciaio inossidabile estensibile



~~€ 20,70~~

€ 14,50

831 A

Cod. U08310001

Goniometro digitale

- Permette serraggi angolari di precisione digitale in totale semplicità
- Per serraggi destrorsi e sinistrorsi
- Scala: 0÷360° con risoluzione 0,1°
- Doppia indicazione: luminosa (LED) e sonora (buzzer) al raggiungimento del valore impostato
- 9 valori di angolo obiettivo preimpostabili
- 50 misurazioni memorizzabili
- Fornito in custodia di ABS con certificato di taratura
- Alimentazione: 2 batterie AAA (incluse nella confezione)



~~€ 165,00~~

€ 115,00



YouTube

 Nuovo prodotto

Articolo	Pag	Articolo	Pag	Articolo	Pag	Articolo	Pag	Articolo	Pag
0		280 TK/SE6	16	516 SPC2	57	519 R7/3V	52	600	
002 JMA	42	280 TSTX/SE4	15	518 SP6A-S	51	519 R8/3V	52	601 1/2 J22	29
002 JTMA	43	280 TTS/SE6	15	518 SP6I-S	51	519 RA1	54	601 1/4 J34	29
007 FTSV	45	280 XLTS/S9	17	518 SP6V	50	519 RA2	54	601 1/4-1/2 J100	28
007 RV	45	283 SE9	24	518 SP7V	50	519 RA3	54	601 1/4-1/2 JTX16	29
007/1V	45	285 DS12	21	519 M 127N	35	519 RA4	54	605 3/8 EA	31
046 L	82	285 DS8	21	519 M 133AX	35	519 RA5	54	606 1/2 EA	31
056 L	82	285 KA/DS12	23	519 M 133AX1	35	519 RA6	54	606 1/4 EA	31
074 A	68	285 KA/DS8	23	519 M 150AX	35	519 RA8	54	606 1/4 SK	19
076 A	68	285 KA/SE5	23	519 M 233C24	35	519 RA9	54	610 1/4 EFK	19
085 EX/SE2	7	285 KB/SR8	24	519 M 235M	35	519 RC1	57	612 1/2 MPA	32
085 EX/SE3	7	285 KF/DS8	24	519 M 236K	35	519 RC2	57	612 3/4 EB	32
091 D/SH5	6	285 SE26	21	519 M 236K1	35	519 SKV6	38	612 3/4 ESI	32
091 SH5	6	294 AD	26	519 M 236K2	35	519/091H	38	646/5LV	44
091 SH8	6	294 AG	27	519 M 276	37	519/127C	38	654 RV	55
100		300		519 M 280N1	35	519/127N	38	692 J100	18
115 CL	77	314 C	69	519 M 280TK	35	519/150AX	38	692 J32	18
115 CLP	77	317 BM	69	519 M 285A1	36	519/200I	39	692 J49	18
115 CP	77	317 EM	69	519 M 285A2	36	519/233A	38	800	
127 C/SE4	13	324 SH12	5	519 M 285KA	36	519/234C	38	810 F	33
127 C/SEAS	13	324 SH8	5	519 M 285KF	36	519/235LN	38	810 N	33
127 N/SE4	12	324 STX/S7	5	519 M 291N13	36	519/252A1	38	812 N	33
127 N/SE4S	12	333 K/B10	16	519 M 322H	36	519/276	39	831 A	82
134 A	10	367 SE6	70	519 M 322STX	36	519/280T	39	870 C	76
135 A	10	372 SE6	70	519 M 324H	36	519/280TK	38	871 AN	76
135 B	10	376 F	70	519 M 324STX	36	519/283	38	871 C	76
135 C	10	382 F	70	519 M 333K	36	519/285A1	38	871 D	76
146 A	67	400		519 M 382F	36	519/285B2	38	889 RD	65
146 B	67	443 N	74	519 M 425TPMS	36	519/285KA1	38	889 RP	65
150 AX/SE2	9	443 NC	74	519 M 612CLA	37	519/285KF	38	889 SA	64
150 AX/SE3	9	446 S28	75	519 M 612EB	37	519/291NA	38	889 TL	63
150 AX/SP2	9	447 T	79	519 M 612ESI	37	519/294	38	889 TM	63
155 AX	11	451 N/S4	72	519 M 612MPA	37	519/299	38	889 TR	63
163	67	454 SE3	72	519 M 613AEA	36	519/322H	38	889 TS	63
200		458 S8	72	519 M 613AEB	36	519/322STX	38	889 UB	64
200	71	495 A-PL	41	519 M 613BEA	36	519/324H	39	900	
200 F	71	495 A-SP	40	519 M 613BEB	36	519/324TX	39	928 AC1 1/2	61
200 S	71	495 I-PL	41	519 M 613CEA	36	519/366	39	928 D1 3/4	62
207 E	66	495 I-SP	40	519 M 613CEB	36	519/382	39	929 PC1 1/2	61
236 K 1/2	59	495 MA	40	519 M 824SK11	36	519/382F	39	942 PC3 1/2	62
236 K 1/4	59	498 B	56	519 M 824SK13	36	519/607AEA	39	943 PC1 1/2	60
236 K/C13	59	500		519 M 824SK23	37	519/607CA	39	943 PC2 1/2	60
236 K/C20	59	501 P	56	519 M 929PC1	37	519/607CEA	39	1000	
236 K/C27	59	502 R1V	55	519 M 942PC3	37	519/607ICEA	39	1613 AB12	80
237 A 1/2	30	502 R2V	55	519 M 943PC1	37	519/613AEA	39	1613 AB12-24	80
237 A 1/4	30	504 S	54	519 M 990A5B	37	519/613BEA	39	1881 S22	81
237 A 3/8	30	506 A2	56	519 M 990A5MD	37	519/613CEA	39	1950 C3	78
263 RA	75	513 B6V	52	519 M 995K	37	519/615AEA	39	1950 C6	78
263 S16	75	514 B6V	54	519 MSK6	35	519/960	39	2000	
270 B/C3	77	516 SP6A-P	47	519 R6/3A-S	53	519/990A1	39	2000 A	79
273 1/2 Q/SE9	25	516 SP6I-P	47	519 R6/3I-S	53	519/990AB1	39	2847/3	81
276 CE/SE5	25	516 SP6V	46	519 R6/3NV	52	531 C	44	2550 A	78
276 CE/SE8	25	516 SP6XLM	49	519 R6/3V	52	532 A	44	2550 B	78
280 LTS/S9	17	516 SP6XLV	48	519 R6/4NV	52	532 B	44	3000	
280 LTSTX/S8	17	516 SP7V	46	519 R6/4V	52	532 C	44	3500 S1P	73
280 T/SE7	15	516 SPC1	57	519 R6/5V	52	532 D	44		

PRODOTTI UNICI SUL MERCATO. SOLO USAG TE LI PUÒ OFFRIRE!



Informazioni dettagliate sugli Iconic Product: **usag.it**

Offerta valida fino al 31 gennaio 2020 salvo esaurimento scorte, presso i Rivenditori che aderiscono all'iniziativa.

Tutti i prezzi sono da intendersi in Euro, IVA esclusa. Le immagini riprodotte in questa brochure sono indicative.
Stanley Black & Decker Italia S.r.l. si riserva in ogni momento di modificare le caratteristiche tecniche dei prodotti.

TIMBRO DEL RIVENDITORE

